

Techno-vet

Primary scan initiating...
Warning Heart Attack Imminent
Heart Failure: treatment: diuretics
Heart Attack: treatment: propranolol
Heart Attack: treatment: anticoagulant
Heart Failure: treatment: vasodilator
Heart Failure: treatment: cardiac glycoside
Begin cardiopulmonary resuscitation

Heart Attack: treatment: anticoagulant
Heart Failure: treatment: vasodilator

Heart Failure
Heart Failure

Heart Attack
Heart Attack
Heart Failure
Heart Failure
Warning Heart
Heart Failure
Heart Attack



Resources for a healthy image

Terms & Conditions

Terms

- Net 30 days for approved accounts.
- New accounts may be opened on a Prepaid basis pending credit approval.
- Freight Charges are prepaid and added to the invoice.
- Invoiced shipping, handling, and insurance charges are \$9.95 or greater, depending on actual freight costs.
- FOB Destination: Freight Prepaid and Added from Nashville, TN, USA, or other authorized location.
- In Tennessee and Illinois, Sales Tax is billed unless a valid exemption certificate is on file with Techno-Aide at the time an order is placed (Required by Federal Law).
- International Customers: All terms and policies are governed by specific Pro Forma Invoice.
- For your convenience, we accept MasterCard, VISA, American Express and Discover for prepaid orders.

- **PRICING:** Our policy is to hold prices firm from one catalog printing to the next. We do reserve the right to change prices or discontinue products without notice, but only as a last resort.

- **SPECIAL NOTE:** Motor freight companies will not unload shipments to accounts who do not have a suitable commercial height receiving dock, nor will they unload large or heavy items to ground level. Many times, however, advanced arrangements for curbside unloading can be made by facility personnel or the shipment can be made to your location for dealer delivery. For an additional charge and notification at the time of order, "Inside Delivery" or Cartage can be requested. The specifics of this service, however, are governed by your local freight terminal.

Return Policy

- Products cannot be returned to Techno-Aide, for credit or otherwise, unless accompanied by a Return Authorization Number issued by the Customer Service Department.
- All authorized returns are subject to a minimum 20% refurbishing and reconsignment fee.
- All protective apparel returns are subject to a minimum 50% breakdown and restocking fee.
- All returns must be shipped in the original packaging.
- No returns 45 days past the invoice date will be allowed.
- Techno-Aide will authorize returns for complete credit in the case of Techno-Aide error or defective merchandise.
- A Credit Memo will be issued only after the returned merchandise has been received and inspected by Techno-Aide.
- No returns will be allowed for personalized, custom items or Designer Colors unless they are defective.
- Damages on returned items are the responsibility of the shipper. For proper credit to be considered, every effort should be made to assure a damage-free return.

Damaged Goods Policy

- The carrier has signed for receipt of merchandise from our factory and has accepted them in good condition.
- If your shipment arrives damaged or incomplete, it is the consignee's (ship-to) responsibility to note visible damage or shortages on the Bill of Lading BEFORE the carrier leaves. **FAILURE TO NOTE ANY DISCREPANCIES ON THE BILL OF LADING WILL VOID ANY ATTEMPTED FREIGHT CLAIM and/or DELAY OR FORFEIT ANY CUSTOMER CREDIT.**
- Techno-Aide will be glad to assist you by having an inspector from the carrier come to inspect the shipment and by working with you for any necessary replacements. Replacements are treated as separate orders, requiring their own purchase order number for billing. Any possible credits will be issued on the original order.
- Whether the damage is visible or concealed, **KEEP ALL PACKAGING MATERIALS FOR THE CARRIER INSPECTOR.**
- Reporting and inspection must be made within seven (7) days after delivery. Delayed reporting can delay or void the carrier's responsibility to pay your claim and negate any credit for freight damage from Techno-Aide.

Techno-Aide also manufactures a complete line of diagnostic imaging products that includes lead aprons, carts, cabinets, and many other accessories. Please call us or check our website for more details. And, if you don't find what you're looking for, let us know! www.techno-vet.com or www.techno-aide.com.

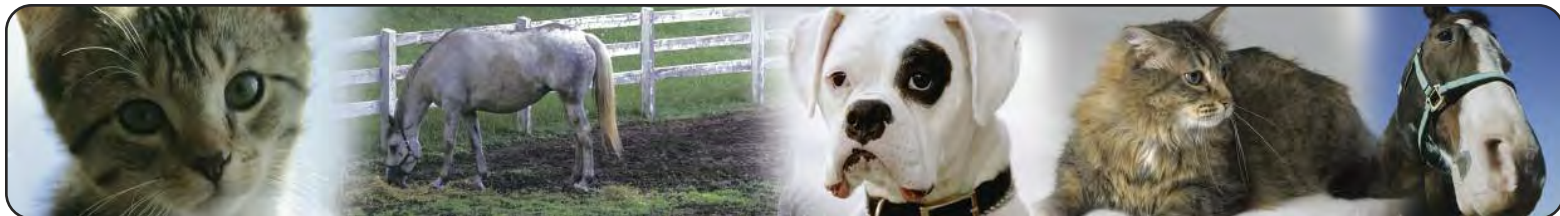

contents

radiation protection

2-9

positioning aids

10-15

clinic accessories

16-25

x-ray markers

26-31

darkroom/viewing

32-33

organizing & filing

34-39

workstations & furniture

40-48

index inside back cover



What makes Techno-Aide Protective Garments different?



Techno-Aide offers THREE TYPES OF PROTECTION for every garment WE MANUFACTURE:

- **REGULAR LEAD** (most economical choice)
- **LIGHT-WEIGHT LEAD** (more expensive than Regular Lead, but about 22% lighter in weight)
- **LMG LEAD-FREE** (42%-45% lighter than Regular Lead, among the lightest material available)
 - **Lean** on weight (over 43% lighter than regular lead)
 - **Mean** on protection (offers the same Pb equivalency as lead)
 - **Green** on the environment (*lead-free* means eco-friendly)

(NOTE: All products are listed with all three choices of protection)

Ex.:	cat.#	lead type	price
	EVR	Regular	\$205.00
	EVL	Light Wt.	\$250.00
	EVG	LMG Lead-Free	\$310.00

All garments include at NO COST:

- Free Shoulder Pads
- Free Double Pockets
- Free Embroidery
- Free Recycling

All Techno-Aide protective garments offer **CONFIDENT RADIATION PROTECTION!**



Techno-Aide will gladly accept your Techno-Aide Brand aprons for RECYCLING. Call for a "Recycle Return Authorization." There will be no charge to you, we only ask that you pay the return shipping. "Non-Lead" apparel does not need to be recycled.



EZ•Guard All Purpose Apron



Most Popular Apron!



- EZ-On / EZ-Off.
- Available with hook & loop or 2" buckle closure.
- 0.5mm Pb equivalency protection (0.375mm available).
- Free dual pocket and shoulder pads.

Hook & Loop cat.#	Buckle Closure cat.#	lead type	petite		2X 3X
			small medium	large x-large	
QEVR	QEBR	Regular	\$205.00	\$220.00	\$245.00
QEVL	QEBL	Light Wt.	\$260.00	\$285.00	\$310.00
QEVG	QEBG	LMG Lead-Free	\$310.00	\$330.00	\$360.00



Flex•Guard Flexible-Back Apron



- Stretch back provides greater comfort by placing more weight on the hips and less weight on the shoulders.
- Available with hook & loop or 2" buckle closure.
- 0.5mm Pb equivalency protection (0.375mm available).
- Free dual pocket and shoulder pads.

Hook & Loop cat.#	Buckle Closure cat.#	lead type	petite		2X 3X
			small medium	large x-large	
QFVR	QFBR	Regular	\$215.00	\$230.00	\$255.00
QFEVL	QFBL	Light Wt.	\$275.00	\$295.00	\$325.00
QFVG	QFBG	LMG Lead-Free	\$325.00	\$340.00	\$365.00



Econo•Guard Economy Apron



Excellent Protection, Value Priced

- 1" buckle closure (long enough to tie).
- 0.5mm Pb equivalency front protection.
- Available in any fabric.
- See Best-Fit size chart on page 8.

cat.#	lead type	petite		2X 3X
		small medium	large x-large	
QEGR	Regular	\$135.00	\$155.00	\$180.00
QEGL	Light Wt.	\$215.00	\$235.00	\$265.00
QEGG	LMG Lead-Free	\$280.00	\$295.00	\$325.00



STANDARD

cat.#	lead type	price
QTYR	Regular	\$49.00
QTYL	Light Wt.	\$58.00
QTYG	LMG Lead-Free	\$70.00

Binding all around means affordable comfort and flexibility.

ATTACHED STANDARD

cat.#	lead type	price
QTAR	Regular	\$61.00
QTAL	Light Wt.	\$69.00
QTAG	LMG Lead-Free	\$82.00



NO BINDING

cat.#	lead type	price
QTNR	Regular	\$64.00
QTNL	Light Wt.	\$72.00
QTNG	LMG Lead-Free	\$84.00

No binding means extra comfort, flexibility and lighter weight.

ATTACHED NO BINDING

cat.#	lead type	price
QTCR	Regular	\$77.00
QTCL	Light Wt.	\$83.00
QTCG	LMG Lead-Free	\$94.00



MID-BINDING

cat.#	lead type	price
QTVR	Regular	\$57.00
QTVL	Light Wt.	\$65.00
QTVG	LMG Lead-Free	\$77.00

No binding at the top means extra comfort under the chin.

ATTACHED MID-BINDING

cat.#	lead type	price
QTVR	Regular	\$69.00
QTVL	Light Wt.	\$77.00
QTVG	LMG Lead-Free	\$88.00

- Collars are 6" tall x 6 1/2" wide x 24" strap.
- Select **COLOR** and **FABRIC** on page 9.
- Default color is **Royal Blue**.
- **FREE Embroidery**; see 8 for options.
- 2-Year warranty on materials and labor.

Thyro•Guards

All Attached Thyroid Collars include:

- Snap ring for easy collar attachment.
- Attach anytime with tethered strap.
- Unique 2-in-1 pocket design: store collar in one pocket and use the other pocket for accessories.

Unique 2-pockets in one



Guard•Tote Apparel Tote Bag

#QACB-28
\$99.00



- Convenient tote for all your protective wear.
- Durable rip-stop nylon fabric with zippered closure.
- 28" long to minimize folding your aprons.
- EZ-Carry handle and shoulder strap included.

Belt•Guard Back Support Belt

#QBGB
\$45.00



- Helps reduce back stress.
- Can be used with any apron.
- 6" elastic back support belt with 2" buckle closure.

Protective Gloves and Mittens for Imaging

Hand•Guard Protective Gloves

- Five fingered protection for full dexterity.
- Durable, soft navy vinyl covering (15").
- 0.5mm Pb equiv. dip-molded core.

HAND•GUARD 5-Finger

cat.#	hand	price
QHGP	Pair	\$220.00
QHGR	Right Hand	\$122.00
QHGL	Left Hand	\$122.00



Palm•Guard

Protective Mittens (Slitted)

- Provides hand protection with option of exposing fingers for dexterity.
- Durable, soft navy vinyl covering (15").
- 0.5mm Pb equiv. dip-molded core.

PALM•GUARD Slitted

cat.#	hand	price
QPSP	Pair	\$290.00
QPSR	Right Hand	\$149.00
QPSL	Left Hand	\$149.00



Palm•Guard

Protective Mittens (Economy)

- Flexible for grasping and holding.
- Colorful fabric on one side (see page 9) and soft-touch neutral on the palm side.
- 0.5mm Pb equivalency.

PALM•GUARD Non-Slit

cat.#	hand	price
QMGP	Pair	\$110.00
QMGR	Right Hand	\$65.00
QMGL	Left Hand	\$65.00



Omni•Guard

Protective Flexible Shield



- Used over an animal or equipment, protects from radiation exposure.
- Used underneath an animal, prevents scatter radiation.
- All purpose covering for humans, animals or equipment.
- 0.5mm Pb equivalency protection.
- Choose any color fabric from page 9.



cat.#	lead type	small	medium	large	x-large
QOMR	Regular	\$107.00	\$144.00	\$169.00	\$192.00
QOML	Light Wt.	\$149.00	\$187.00	\$239.00	\$292.00
QOMG	LMG Lead-Free	\$235.00	\$299.00	\$369.00	\$520.00

size	(width x length)
S	(18" x 18")
M	(24" x 24")
L	(24" x 36")
X	(24" x 48")



ULTRA•GUARD

SILVER	BLACK	TAUPE	lens style	price
QLER-9SPL	QLER-9KPL	QLER-9TPL	Non-Prescription	\$195.00
QLER-9SSV	QLER-9KSV	QLER-9TSV	Single Vision Rx*	\$320.00
QLER-9SBI	QLER-9KBI	QLER-9TBI	Bifocal Rx*	\$340.00

*(Prescription MUST accompany order. Non-returnable)

COLOR•GUARD: Bright-tone colorful Ultra•Guards.

RED	BLUE	ORANGE	lens style	price
QLER-CRPL	QLER-CBPL	QLER-COPL	Non-Prescription	\$195.00
QLER-CRSV	QLER-CBSV	QLER-COSV	Single Vision Rx*	\$320.00
QLER-CRBI	QLER-CBBI	QLER-COBI	Bifocal Rx*	\$340.00

*(Prescription MUST accompany order. Non-returnable)



Ultra•Guard/Color•Guard

Ultra-light and super stylish.

- Curved lens adds to lateral protection.
- Regular hinges with wrap around frame.
- Universal bridge support.
- Available in most prescriptions.
- Includes premium case.
- Lead Equiv.: 0.75mm lens.
- Frame: impact resistant polycarbonate.



POWER•GUARD

BLUE/ORANGE	SILVER/PINK	BLACK/GRAY	lens style	price
QLER-PBPL	QLER-PSPL	QLER-PKPL	Non-Prescription	\$215.00
QLER-PBSV	QLER-PSSV	QLER-PKSV	Single Vision Rx*	\$340.00
QLER-PBBI	QLER-PSBI	QLER-PKBI	Bifocal Rx*	\$360.00

*(Prescription MUST accompany order. Non-returnable)

Power•Guard

Colortone accents increase comfort.

- Large lens area for excellent coverage.
- Soft colored endpiece for comfort and fit.
- Padded bridge, temples, and endpiece.
- Available in most prescriptions.
- Includes premium case.
- Lead Equiv.: 0.75mm lens.
- Frame: impact resistant polycarbonate.



VIVA•GUARD

RAD SKULL	CHERRY VINES	FANCY FLIGHT	lens style	price
QLER-VSPL	QLER-VVPL	QLER-VFPL	Non-Prescription	\$215.00
QLER-VSSV	QLER-VVSV	QLER-VFSV	Single Vision Rx*	\$340.00
QLER-VSBI	QLER-VVBI	QLER-VFBI	Bifocal Rx*	\$360.00

*(Prescription MUST accompany order. Non-returnable)



(ultra-soft bridge)

Viva•Guard

Lively designs for small to medium faces.

- Smaller frame for excellent fit of smaller faces.
- Regular hinges with wrap around frame.
- Ultra soft bridge support.
- Available in most prescriptions.
- Includes premium case.
- Lead Equiv.: 0.75mm lens.
- Frame: impact resistant polycarbonate.

Cover•Guard



Comfortable protection over regular glasses

- Excellent front and side visibility.
- Provides limited splash protection.
- Can be worn over prescription eyewear.

- Regular hinges with molded nose piece.
- Includes premium case.
- Lead Equiv.: 0.75mm front and sides.
- Frame: black rubberized nylon.

cat.#	lens style	price
QLES-CKPL	Non-Prescription	\$150.00

Apron/Glove Racks

- Designed for one apron, but will hold more.
- All steel, heavy duty construction.
- 16" & 24" mounting holes match most wall studs.
- Glove holders mounted onto back panel.
- 28 1/2" long x 1 3/4" diameter bar prevents creasing.
- Ships @ 13 lbs.



Rack without Glove Holders
#QAGR-105 \$145.00



Rack with Two Glove Holders
#QAGR-110 \$195.00



Rack with Four Glove Holders
#QAGR-115 \$245.00

Apron Peg Racks



2-peg
(for 1 apron)
#QARP-02
\$53.00



6-peg
(for 3 aprons)
#QARP-06
\$110.00



- 6" pegs are angled to keep garments from slipping.
- Mounting holes on the 6-peg and 8-peg racks are on both 16" and 24" centers.
- All-steel Almond enamel finish.
- 2-Peg ships @ 4 lb. 6-Peg ships @ 10 lbs.



Wall Mounted Apron Racks



10-ARM #QARW-10 \$340.00



5-ARM, SWING LEFT #QARW-L5 \$199.00



5-ARM, SWING RIGHT #QARW-R5 \$199.00

- Ten (10) or five (5) swing-arm wall-mount apron racks.
- Mounting holes on 16" centers.
- All-steel durability.
- Almond enamel finish.
- 10-Arm Ships @ 25 lb. / 5-Arm Ships @ 17 lb.



Best-Fit Sizing Charts

Front Protection Apron

- EZ•Guard (EV, EB)
- Flex•Guard (FV, FB)
- Econo•Guard (EG)

size	actual WxL	dress size	coat size
Child	18"x24"		
Petite	18"x30"	1-2	30-32
Small	20"x32"	4-6	34-36
Medium	22"x36"	8-10	38-40
Large	24"x38"	12-14	42-44
XLarge	26"x40"	16-18	46-48
2X	28"x40"	20-22	50-52
3X	30"x40"	24-26	54-58

The measurements listed in our product descriptions are the actual sizes of the protective material.

- **Width:** guards at least **half your circumference;**
- **Length:** sternal notch to just **above or below your knee**, depending on your preference.
- **Custom Sizes:** submit your measurements according to the diagram to the right.

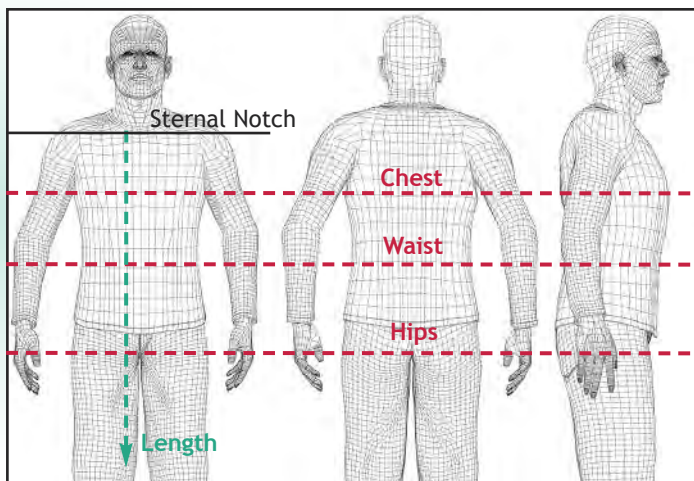

Things to Remember

ORDERING ASSISTANCE:

- Free sizing skins are available to "pre-fit" custom garments!
- Fabric sample swatches are available upon request.
- Check your measurements to assure that a custom garment is made to the intended size.

CARE AND MAINTENANCE:

- Always hang your garment on large diameter hangers. Do not wad or fold your garment, as that may weaken the level of protection on the folded seam.
- Do not store sharp objects in the pockets or store the garment on top of a sharp object.

WARRANTY:

- Two-Year Warranty on materials and workmanship.

Cleaning Your Apron



alcohol super wipes

#QGWP-P55 \$12.50/each tub

Save on shipping:

#QGWP-P55CS \$153.00/case of 12 tubs

- Use once, throw away, quick drying.
- Contains the highest range of effectiveness.
- Alcohol content: High @ 55%.
- Recommended Contact Time: 2-minutes or less.
- Great for cleaning and disinfecting **APRONS.**

Embroidery (FREE Option!)

- Selected Techno-Aide Protective Apparel comes with FREE embroidery!
- Please specify what you want embroidered and which type style you prefer ("BLOCK" is used if not specified).
- Default capitalization: "BLOCK" is generally all-caps; "Script" uses both upper and lower cases.
- Embroidered items are non-returnable, non-refundable.

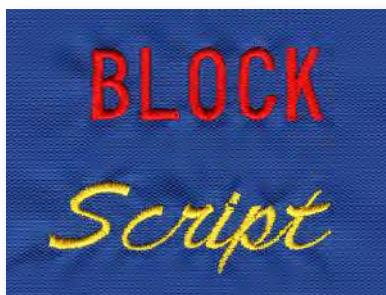

Optional BINDING Colors:

Black (default)	Red
Lt. Gray (default)	Yellow
Navy	Orange
Royal Blue	Tan

(The black or gray stripe on each fabric square is the default binding color for that fabric.)

Optional EMBROIDERY Colors:

White (default)	Red
Black (default)	Yellow
Lt. Gray	Orange
Charcoal	Royal Blue

Nylon Liquid Repellent

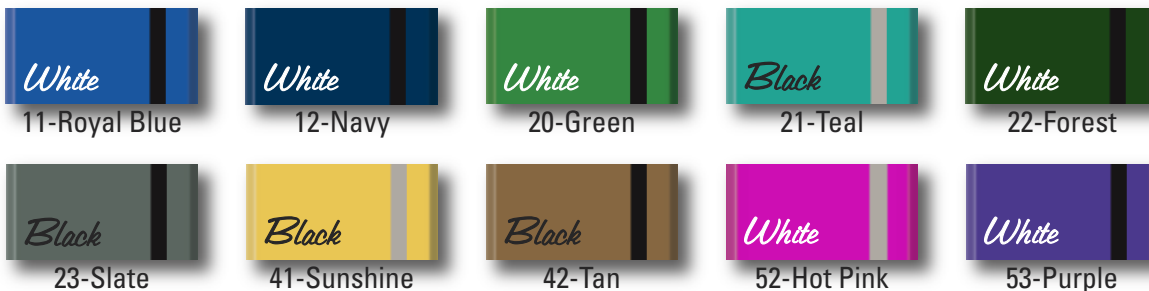

Polyester Prints



(NOTE: Prints are shown SMALLER than actual size)

Ripstop Nylon Filament Reinforced Diamond Polyester



Galaxy Prints High Sheen Liquid Proof PU Laminate



High-Tech Fabrics Textured



Free Stock Embroidery Options



#VEG-Ark



#VED-DogA



#VED-DogB



#VED-PuppyBones



#VED-Bone



#VEF-Ducks



#VEE-HorseShoe



#VEC-CatA



#VEC-Kittens



#VEC-CatB



#VEG-Pals

Please specify by number-name.
Other designs available - call us!

RECTANGLE POSITIONING SPONGES

NON-COATED
STANDARD GRAY SPONGE

COATED
STANDARD SPONGE

(For COATED SPONGES ONLY:
edges may appear on images
using low kVp.)

#QUFBL
\$10.50



3" RECTANGLE
7.5 X 10 X 3

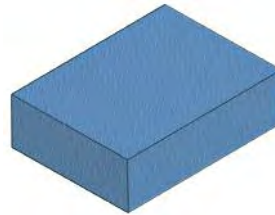

#QUCBL
\$39.00

#QUFBO
\$20.50



4" SQUARE SPONGE
10 X 10 X 4

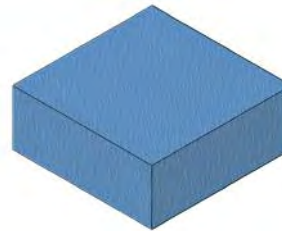

#QUCBO
\$64.50

#QUFBR
\$3.50



1" RECTANGLE
4 X 6 X 1

#QUFBT
\$5.50



2" RECTANGLE
4 X 6 X 2

#QUFBK
\$12.50/set

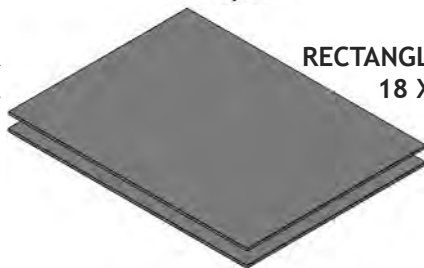

RECTANGLE MAT (SET OF 2)
18 X 24 X 0.25

RECTANGLE USES:

- Use between stifles to maintain alignment.
- To elevate the head/extremities for proper positioning.
- To elevate the body for lateral decubitus views.

SPECIALTY USES:

- To maintain alignment and duplicate positioning.
- To decrease motion and improve quality.
- To elevate the head above the shoulders.

(Other shapes and sizes available.)

#QUFAH
\$37.00



BOLSTER BLOCK
10 X 12 X 8

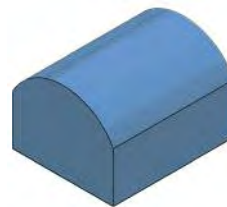

#QUCAH
\$107.00

#QUFAK
\$10.50



CIRCULAR BLOCK
7 X 1.5



#QUCAK
\$24.00

#QUFAL
\$32.00

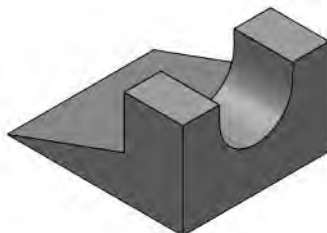

RAMP SUPPORT
12 X 10 X 6.5

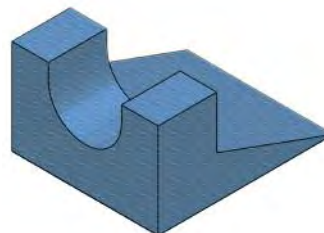

#QUCAL
\$71.00

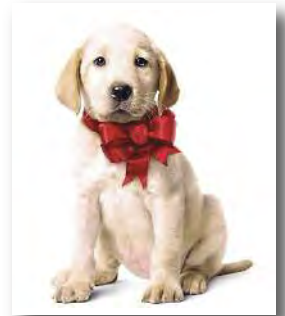

WEDGE POSITIONING SPONGES

NON-COATED STANDARD GRAY SPONGE

COATED STANDARD SPONGE

(For COATED SPONGES ONLY:
edges may appear on images
using low kVp.)

#QUFBE
\$11.50/set

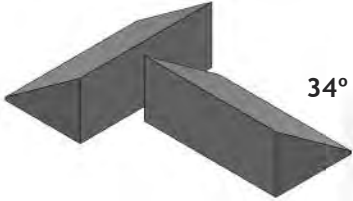

34° WEDGE (SET OF 2)
4 X 7 X 3

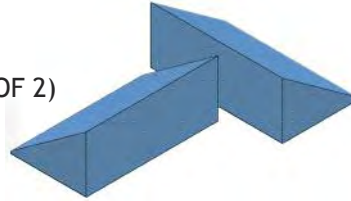

#QUCBE
\$41.50/set



#QUFBH
\$15.00/set



16° WEDGE (SET OF 2)
7 X 8 X 3.5

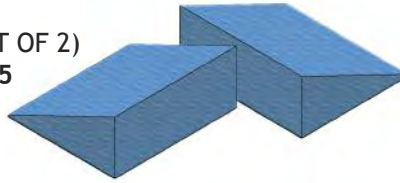

#QUCBH
\$77.00/set

#QUFBJ
\$12.50/set



12° WEDGE (SET OF 2)
9.5 X 7.25 X 2.25



#QUCBJ
\$73.50/set

WEDGE USES:

- Lateral projection of pelvis when placed between hind limbs.
- To maintain horizontal alignment of sternum and spine.
- Placed under sternum to keep ribs superimposed for lateral thorax.
- For lateral view of extremities to keep body parts lateral or extended in proper position and helps keep the stifle parallel to the image receptor.
- For oblique positioning.

(Other sizes available.)

#QUFBB
\$18.50



45° WEDGE
7 X 14 X 7



#QUCBB
\$67.50

#QUFBC
\$16.00



45° WEDGE
7 X 7 X 7



#QUCBC
\$43.50

#QUFBU
\$25.50

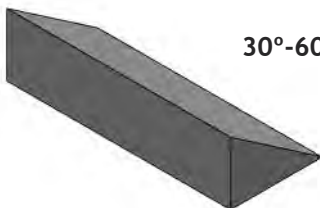

30°-60°-90° MULTI-ANGLE
10 X 24 X 6

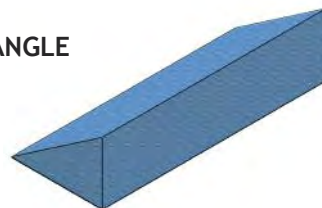

#QUCBU
\$179.00

#QUFBG
\$10.50



21° WEDGE
10 X 10 X 4.63



#QUCBG
\$62.00



GENERAL SPONGE KITS

(For COATED SPONGES ONLY: edges may appear on images using low kVp.)



VET KIT A

Uncoated *OR* Coated Kit includes:

UNCOATED	DESCRIPTION	COATED
QUFBD	45° Wedge (7x21.5x7)	QUCBD
QUFBI	(2) 15° Wedge (11x7x3)	QUCBI
QUFBL	Rectangle (7.5x10x3)	QUCBL
QUFBT	Rectangle (4x6x2)	QUCBT
QUFAK	Circular Block (7x1.5)	QUCAK

NON-COATED

#QUKVA
\$62.00

COATED

#QUSVA
\$262.00

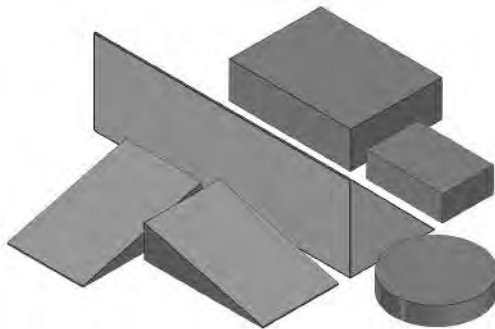

VET KIT B

Uncoated *OR* Coated Kit includes:

UNCOATED	DESCRIPTION	COATED
QUFBE	(2) 34° Wedge ((4x7x3)	QUCBE
QUFBK	(2) Rectangle (18x24x.25)	QUFBK (not coated)
QUFBG	21° Wedge (10x10x4.63)	QUCBG
QUFAH	Bolster (10x12x8)	QUCAH
QUFAL	Ramp Support (12x10x6.5)	QUCAL
QUFAM	Cradle (10x11x6.75)	QUCAM

NON-COATED

#QUKVB
\$130.00

COATED

#QUSVB
\$390.00

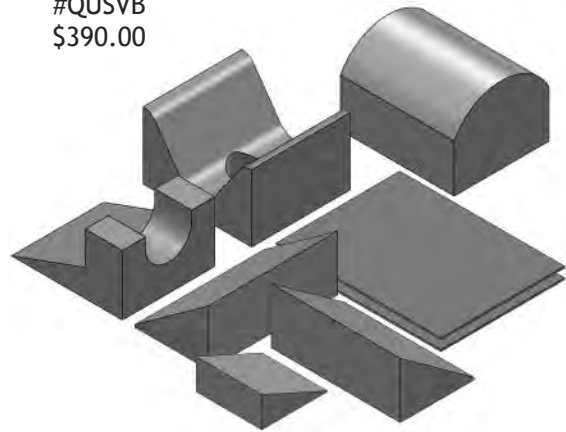

VET KIT C

Uncoated *OR* Coated Kit includes:

UNCOATED	DESCRIPTION	COATED
QUFBI	(2) 15° Wedge (11x7x3)	QUCBI
QUFBC	45° Wedge (7x7x7)	QUCBC
QUFBH	(2) 16° Wedge (7x8x3.5)	QUCBH
QUFBB	45° Wedge (7x14x7)	QUCBB
QUFBU	15°-30°-60° Wedge (10x24x6)	QUCBU
QUFBR	(2) Rectangle (4x6x1)	QUFBR (not coated)
QUFBT	(4) Rectangle (4x6x2)	QUCBT

NON-COATED

#QUKVC
\$110.00

COATED

#QUSVC
\$512.00

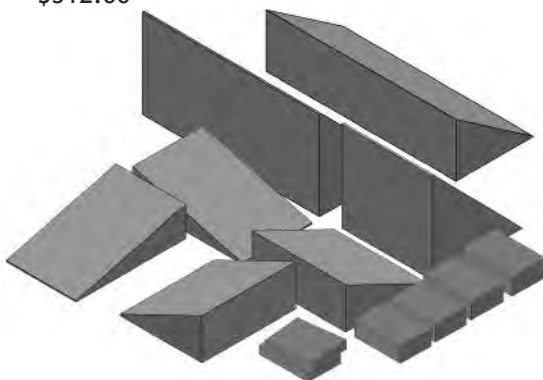

VET KIT D

Uncoated *OR* Coated Kit includes:

UNCOATED	DESCRIPTION	COATED
QUFBH	(2) 16° Wedge (7x8x3.5)	QUCBH
QUFBC	45° Wedge (7x7x7)	QUCBC
QUFBB	45° Wedge (7x14x7)	QUCBB
QUFBU	15°-30°-60° Wedge (10x24x6)	QUCBU
QUFBQ	(2) Rectangle (4x6x.5)	QUFBQ (not coated)
QUFBR	(2) Rectangle (4x6x1)	QUFBR (not coated)
QUFBS	(2) Rectangle (4x6x1.5)	QUFBS (not coated)
QUFBT	(2) Rectangle (4x6x2)	QUFBT (not coated)

NON-COATED

#QUKVD
\$112.00

COATED

#QUSVD
\$366.00

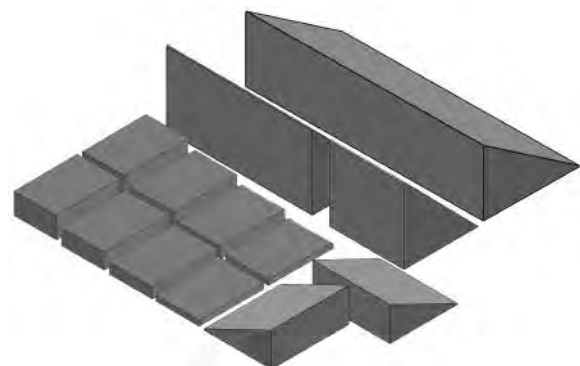

Veterinary Immobilizers

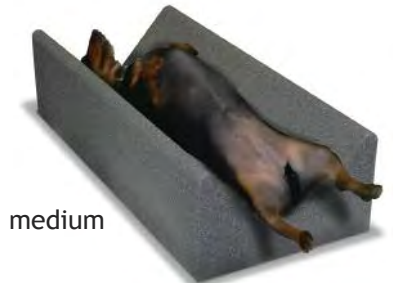

NON-COATED STANDARD GRAY SPONGE

Soft, open cell, polyurethane foam provides excellent support and comfort. This foam has minimal attenuation, is fire retardant, and has been the industry standard for decades. **(NOT claw or teeth proof!)**

COATED STANDARD SPONGE

This is the same standard gray sponge outlined above, but is coated with a medical-grade, durable and easy-to-clean vinyl surface that is resistant to blood, Betadine®, barium, alcohol, oils and other fluids. Attenuation is very low (*edges may show, depending on techniques using low kVp*). Ideal for sterile environments. **(NOT claw or teeth proof!)**

- Decrease motion and position animals for a variety of procedures.
- Ideal for ventrodorsal view of thorax.
- Non-coated sponges can be placed in covers to keep clean from urine and feces.
- Coated immobilizers can be cleaned for instant reuse.
- As with any soft styled product of this nature, please be aware of claw and teeth punctures to preserve the long life of the sponge or coating.



Non-Coated Immobilizers

cat.#	size	length x width x height	Price
QUFCA	small	10" x 4" x 3"	\$19.50
QUFCB	medium	15" x 7" x 5"	\$32.00
QUFCC	large	24" x 11" x 7"	\$61.00
QUFCD	x-large	36" x 14" x 9"	\$108.00

Coated Immobilizers

cat.#	size	length x width x height	Price
QUCCA	small	10" x 4" x 3"	\$45.00
QUCCB	medium	15" x 7" x 5"	\$99.00
QUCCC	large	24" x 11" x 7"	\$225.00
QUCCD	x-large	36" x 14" x 9"	\$299.00

Immobilizer Poly Bag Covers

- 2mil bags protect foam blocks.
- Prevents contamination.
- Non-sterile.
- Bag size is immobilizer size.

Cat.#	Description	Qty./Ctn	Price
QNVC-S	Poly Cover: Small	1000/ctn	\$145.00
QNVC-M	Poly Cover: Medium	500/ctn	\$145.00
QNVC-L	Poly Cover: Large	500/ctn	\$245.00
QNVC-X	Poly Cover: X-Large	200/ctn	\$245.00



Sandbags

- Adequate weight to secure limbs during positioning.
- Stabilizes skull and neck dorsally.
- Provides immobilization to avoid manual restraint.
- All sandbags are filled with sand and are ready to use.
- Heat sealed inner sleeve prevents the leakage of sand.
- All seams are sewn and tear resistant.
- Outer cover is heavy gauge, reinforced vinyl.
- Every sandbag includes a reinforced webbing handle.



2-lb 4" x 9"
Cat.#QSBP-02
\$22.00 ea.



3-lb 5" x 9"
Cat.#QSBP-03
\$22.00 ea.



5-lb 5" x 12"
Cat.#QSBF-05
\$28.00 ea.



5-lb 7" x 9"
Cat.#QSBP-05
\$28.00 ea.



5-lb 9" x 9"
Cat.#QSBC-05
\$28.00 ea.



7-lb 10" x 10"
Cat.#QSBG-07
\$32.00 ea.



7-lb 6" x 14"
Cat.#QSBF-07
\$32.00 ea.



10-lb 7" x 16"
Cat.#QSBF-10
\$34.00 ea.



10-lb 11" x 11"
Cat.#QSBC-10
\$34.00 ea.



15-lb 12" x 12"
Cat.#QSBG-15
\$39.00 ea.

Sandbags Kits



general set (a)

#QSBK-GA \$219.00 set

- Set: (2) 3-lb/5" x 9" (2) 7-lb/6" x 14"
(1) 5-lb/5" x 12" (2) 10-lb/11" x 11"
(1) 5-lb/7" x 9"



general set (b)

#QSBK-GB \$169.00 set

- Set: (2) 3-lb/5" x 9"
(2) 7-lb/6" x 14"
(2) 10-lb/11" x 11"

Sandbag Colors
(Sandsocks *not* included)

- Green (default)
- Black
- Red
- Blue
- Yellow

Includes weight ID tag.

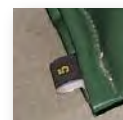

Sandsocks

- Sandsocks are loosely filled sandbags that contour to a broad range of shapes and forms.
- Stabilizes hard-to-hold and irregular anatomy.
- No need for additional person to hold the animal.
- Double seams for strength and longevity.
- Flexible, heavy gauge, reinforced vinyl.



Custom Sizes Available!

1-lb 2" x 8"

#QSBS-01
\$28.00 ea.



3-lb 4" x 12"

#QSBS-03
\$29.00 ea.



5-lb 5" x 15"

#QSBS-05
\$33.00 ea.



10-lb 6" x 20"

#QSBS-10
\$36.00 ea.



12-lb 6" x 25"

#QSBS-12
\$39.00 ea.



10-lb 6" x 28"

#QSBS-28
\$39.00 ea.



10-lb 6" x 34"

#QSBS-34
\$44.00 ea.



15-lb 6" x 40"

#QSBS-40
\$49.00 ea.



15-lb 6" x 46"

#QSBS-46
\$54.00 ea.

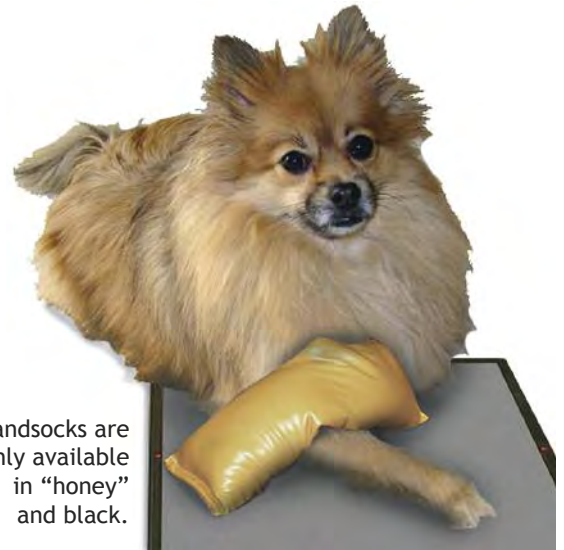

Sandsocks are only available in "honey" and black.



Includes weight ID tag.



sandsock kit

#QSBK-SA \$157.00 set

(Contains the first five sandsocks shown.)

Set: (1) 1-lb/2" x 8" (1) 10-lb/6" x 20"
(1) 3-lb/4" x 12" (1) 12-lb/6" x 25"
(1) 5-lb/5" x 15"

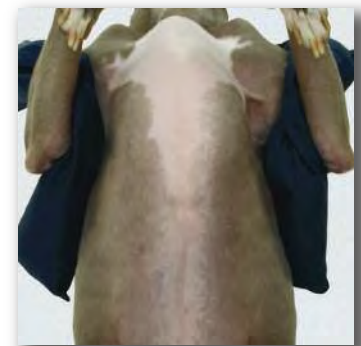

Techno-Shield Mobile Barriers

A mobile barrier should offer greater protection than an apron. Techno-Shield offers **2.0mm Pb Equivalency** protection!



#QPMB-3024
(Call for Price)
Leaded Glass: 30"w x 24"h
Opaque Panel: 30"w x 48"h
Overall Size: 30"w x 75"h
Ships @ 110 lbs.



#QPMB-3060
(Call for Price)
Leaded Glass: 30"w x 60"h
Opaque Panel: 30"w x 12"h
Overall Size: 30"w x 75"h
Ships @ 113 lbs.



#QPMB-4836
(Call for Price)
Leaded Glass: 48"w x 36"h
Opaque Panel: 48"w x 36"h
Overall Size: 48"w x 75"h
Ships @ 225 lbs.

Bring a full **2.0mm Pb Equivalency** of radiation protection anywhere you need it with our new x-ray protective mobile barriers.

Each Barrier features:

- Transparent/clear upper section of x-ray protective leaded glass;
- Opaque lower section of solid leaded x-ray protection;
- Locking caster system for easy mobility (it is recommended that two people move the barrier for safety);
- Crated for secure shipment;
- Some items ship in 2-3 days (check availability)

Leaded Glass panels by **Schott**, the world leader in protection and quality.

Techno-Shield: Real Stopping Power!



Standard Shield

- 0.5mm Pb equivalency.
- Shield area: 24" x 24", 36", or 48".
- Adjustable height: 36" to 60".
- Stable, five-legged star base.
- Default color: royal blue.

cat.#	shield style	width x height	price
QLPS-S2424	solid	24" x 24"	\$520.00
QLPS-S2436	solid	24" x 36"	\$555.00
QLPS-S2448	solid	24" x 48"	\$590.00



Deluxe Shield

- 0.5mm Pb equivalency.
- Shield area: 30" x 30" or 42".
- Adjustable height: 36" to 60".
- Steady all steel T-base.
- Hardened chrome steel post.
- **Posi-Lock** height adjustable arm with spring-loaded pin.
- Default color: royal blue.

cat.#	shield style	width x height	price
QLPS-T3030S	solid	30" x 30"	\$645.00
QLPS-T3030P	5-panel	30" x 30"	\$695.00
QLPS-T3042S	solid	30" x 42"	\$695.00
QLPS-T3042P	5-panel	30" x 42"	\$795.00



Lead Blockers

- Maximize efficiency and optimize use of imaging.
- Divides receptor for multiple exposures.
- Covered with blue vinyl laminate.
- Blockers are FLEXIBLE.
- 1mm lead equivalency.



cat.#	blocker size	fits cass./plate	price
QFLB-58	5" x 8" (13x18cm)	8 x 10	\$35.00
QFLB-52	5" x 12" (13x30cm)	10 x 12	\$45.00
QFLB-61	6" x 10" (15x24cm)	10 x 12	\$45.00
QFLB-71	7" x 11" (18x28cm)	11 x 14	\$55.00
QFLB-77	7" x 17" (18x43cm)	14 x 17	\$80.00
QFLS-78	set of all FIVE	Save 10%	\$234.00



Mobile Holder for CR/DR/Film Image Receptors Standard Tilt & Rotate

Standard Tilt & Rotate
(complete mobile unit)
#QMCH-33B
\$995.00

UNIT INCLUDES:

- Vertical range from bottom of image receptor: floor-to-54".
- *Posi-Lock* height adjustable arm with spring-loaded pin.
- Features 60" chromed steel post.
- 24" H-Base with locking casters.
- Broad base prevents tipping.
- Platinum baked enamel finish.
- Ships in two cartons: 1@15#, 1@45#.

**H-Style Base
Provides Greater
Stability and
Movement!**

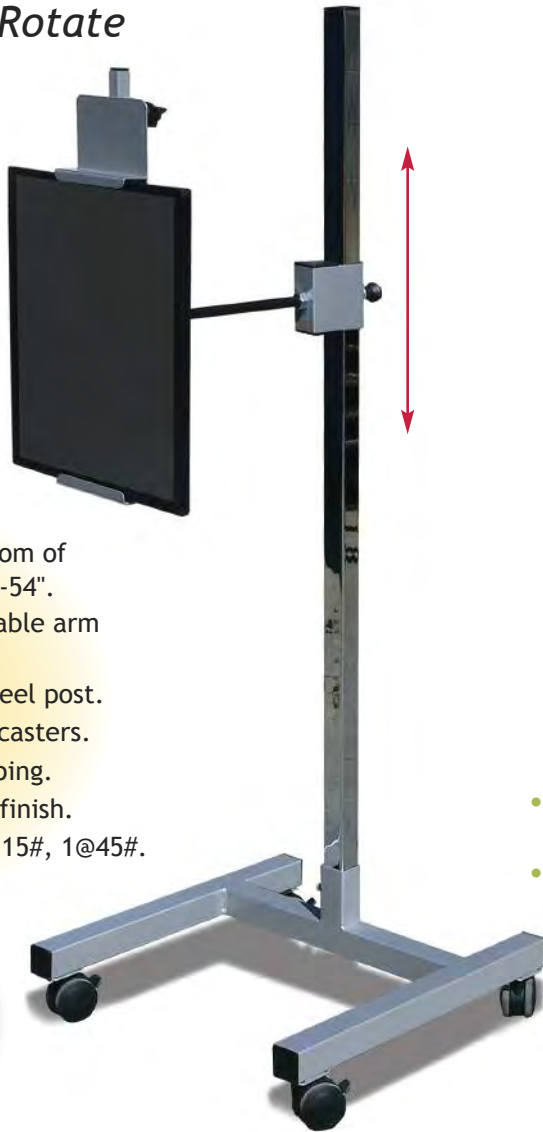

- Standard arm length provides maximum stability.
- Fully articulating holder.

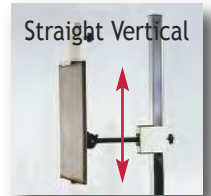

Tabletop Lateral Cassette/CR-Plate/DR-Plate Holders

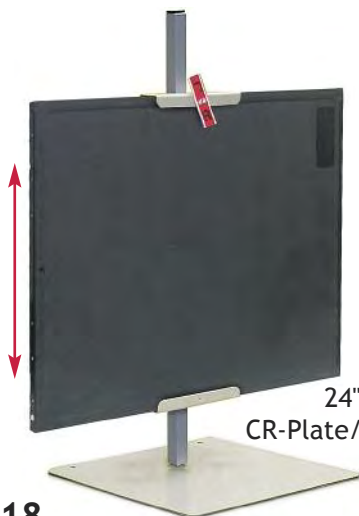

24" Variable Height
CR-Plate/Cassette Holder
#Q35LCH
\$220.00



- Accepts grids and caps (channel is 1 1/4" d).
- Upper and lower channels slide on 24" post.
- Holds plates/cass. for up to 14" x 17" image sizes.
- Base plate slides under patient or pad.
- 35LCH upper channel includes a R & L marker.
- 40LDH features an upper channel that fits into handle and an extra large base for stability.
- Upper and lower channels are lined with rubber.
- Shipping weight: 35LCH @ 7 lbs / 40LDH @ 9 lbs.

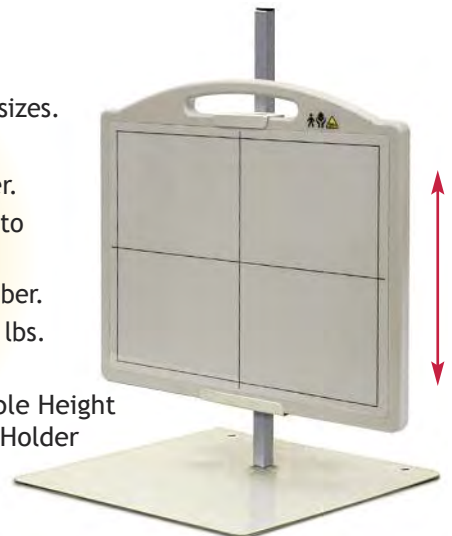

24" Variable Height
DR-Plate Holder
#Q40LDH
\$250.00

Equine Cassette/CR-Receptor Holder



Cat.# QNE305
\$275.00

- 72" tall post allows a variety of views.
- 12-gauge steel base provides stability.
- Two 6" wide channels adjust to fit cassette or CR plate.
- Holds up to 14" x 17" standard cassettes; can hold 14" x 36" or 51".
- Adjustable from ground upward.
- Accepts Grid Cassettes.
- Ships in two cartons: 1@3#, 1@12#.



Equine Back-Saver Receptor Plate Holder

(Right Front) (Left Front)

Turn the holder around to alternate between right and left positions.

Cat.# QNE207
\$275.00

- Back-Saver; no bending to keep the cassette in position (keep steady with foot and hand).
- Eliminates hand held plate/cass. hazards.
- Cassette clamps onto holder.
- Horizontal Staff stores on the base for convenience.
- Dimensions: 48" tall x 36" adj. arm.
- Shipping weight: 12 lbs.

(storage configuration)



Right Leg Position



Left Leg Position



CR/DR/Film Receptor Covers

- Non-sterile and disposable convenience.
- 2 mil polyethylene is transparent to x-ray.
- Keeps receptors clean and dry from exposure to urine, feces, blood, etc.



- Standard folding flap closure:

cat.#	for receptor size	quantity	price
QCCS-08	8" x 10"	1 box of 100	\$59.00
QCCS-10	8" x 10"	1 case of 500	\$268.00
QCCM-10	10" x 12"	1 box of 100	\$59.00
QCCM-12	10" x 12"	1 case of 500	\$268.00
QCCL-14	14" x 17"	1 box of 100	\$59.00
QCCL-17	14" x 17"	1 case of 500	\$268.00
QCCD-DR*	fits 17" x 17" DR	1 box of 100	\$59.00
QCCD-DR*	fits 17" x 17" DR	1 case of 500	\$268.00

*Available for 17" x 17" DR-Receptors!



No Image Compromise!



Compact Dispenser Box

Animal Transporters

- Safe and easy way to transport animals.
- Flexible style rolls up for easy storage.
- Easy to clean and disinfect.



SMALL
#QATS-30
\$75.00



MEDIUM
#QATM-39
\$95.00

RUGGED CONSTRUCTION:

- Made of automotive grade reinforced vinyl.
- Buckle closures on 2" webbing straps (NO hook & loop to accumulate fur and dander!).
- Includes six (6) handles of 1" webbing.
- 1" webbing extends underneath for added strength.



LARGE
#QATL-48
\$115.00



Germicidal Wipes



SANI-CLOTH® “Super” Wipes (the Purple Top!)

- Contains the highest range of effectiveness.
- Cleans, disinfects, deodorizes.
- Alcohol content: High @ 55%.
- Recommended Contact Time: 2-minutes or less.
- Popular industry choice for most **IMAGING EQUIPMENT**.
- Also recommended for **KEYBOARDS and APRONS**.
- EPA registered; meets CDC and OSHA guidelines.

cat.#	wipe size	quantity	price
QGWP-P55	6" x 6 ³ / ₄ "	tub of 160 wipes	\$12.50
QGWP-P55CS	6" x 6 ³ / ₄ "	case of 12 tubs	\$153.00
QGWP-PL55	7 ¹ / ₂ " x 15"	tub of 65 wipes	\$15.00
QGWP-PL55CS	7 ¹ / ₂ " x 15"	case of 6 tubs	\$90.00
QGWP-PW55	5" x 8"	box of 50 packets	\$14.80
QGWP-PW55CS	5" x 8"	case of 10 boxes	\$148.00
QGWP-PT55	11 ¹ / ₂ " x 11 ³ / ₄ "	box of 50 packets	\$46.00
QGWP-PT55CS	11 ¹ / ₂ " x 11 ³ / ₄ "	case of 3 boxes	\$138.00



SANI-CLOTH® Alcohol-Free Wipes (NEW White Top!)

- Contains an excellent range of effectiveness.
- Cleans, disinfects, deodorizes.
- Alcohol content: ALCOHOL-FREE (less than 0.016%).
- Recommended Contact Time: 3-minutes or less.
- Commonly used to disinfect **ULTRASOUND and IMAGING EQUIPMENT**.
- EPA registered; meets CDC and OSHA guidelines.

cat.#	wipe size	quantity	price
QGWP-WAF	6" x 6 ³ / ₄ "	tub of 160 wipes	\$13.50
QGWP-WAFCS	6" x 6 ³ / ₄ "	case of 12 tubs	\$162.00
QGWP-WLAF	7 ¹ / ₂ " x 15"	tub of 65 wipes	\$16.50
QGWP-WLAFCS	7 ¹ / ₂ " x 15"	case of 6 tubs	\$99.00
QGWP-WWAF	5" x 8"	box of 50 packets	\$15.80
QGWP-WWAFCS	5" x 8"	case of 10 boxes	\$158.00
QGWP-WTAF	11 ¹ / ₂ " x 11 ³ / ₄ "	box of 50 packets	\$49.00
QGWP-WTAFCS	11 ¹ / ₂ " x 11 ³ / ₄ "	case of 3 boxes	\$147.00

	SUPER	AF		SUPER	AF		SUPER	AF
Acinetobacter baumannii	•	•	Escherichia coli (E. coli)	•	•	Pseudomonas aeruginosa	•	•
Adenovirus	•	•	Escherichia coli O157:H7 (E. coli)	•	•	Respiratory Syncytial Virus	•	•
Avian Influenza A Virus (H5N1)	•	•	Hepatitis B Virus	•	•	Rhinovirus	•	•
Burkholderia cepacia	•	•	Hepatitis C Virus	•	•	Rotavirus	•	•
Campylobacter jejuni	•	•	Herpes Simplex Virus, Type 2	•	•	Salmonella enterica	•	•
Candida albicans	•	•	HIV-1 (Aids Virus)	•	•	(formerly Salmonella choleraesius)	•	•
Comm. Acquired Methicillin Resistant Staphylococcus aureus (CA-MRSA) Genotype USA300	•	•	Human Coronavirus	•	•	Staphylococcus aureus	•	•
Comm. Acquired Methicillin Resistant Staphylococcus aureus (CA-MRSA) Genotype USA400	•	•	Pandemic 2009 H1N1 Influenza A Virus	•	•	Streptococcus pyogenes	•	•
ESBL Producing Escherichia coli (E. coli)	•	•	Influenza A2 / Hong Kong Virus	•	•	TB (Mycobacterium bovis)	•	•
			Klebsiella pneumoniae	•	•	Vaccinia Virus	•	•
			Listeria monocytogenes	•	•	Vancomycin Resistant Enterococcus (VRE)	•	•
			Methicillin Resistant Staphylococcus aureus (MRSA)	•	•			

(Technical bulletin available for further entries.)



T-Spray II™

#QPDC-507
\$114.00 /case

- Clean & disinfect all types of equipment.
- Safe for transducers, probes, etc.
- Contains NO alcohol, phenol or glutaraldehyde.
- Effective bactericide, fungicide, & virucide.
- **Kills MRSA, Avian Flu & HIV-1.**
- Concentrated; just add water.
- 250ml bottles (1-dozen per case).

SANI-CLOTH® Personal Hand Wipes



#QGWP-B65
\$15.75/each tub
Save on shipping:
#QGWP-B65CS
\$94.50/case of 6 tubs

- Kills 99.99% of germs on hands.
- 65.9% alcohol content (effective against MRSA).
- Wipes remove soil; gels alone do not.
- 220 pre-moistened wipes clean & sanitize hands.

Silk Screened Signs

- All signs are constructed of 1/8" thick Trovicel™.
- Double-faced tape is attached to the back of each sign for mounting.
- Large Signs are 8" x 10".
- Small Signs are 4" x 10".

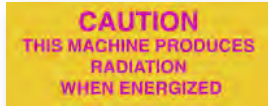

#QCRE-18 \$13.00



#QCRA-17 \$13.00



#QNCP-24B \$13.00



#QNCP-24R \$13.00



#QCXR-13EB \$13.00



#QCXR-13ER \$13.00



#QXRR-19B \$13.00



#QXRR-19R \$13.00



#QCDK-11B \$13.00



#QCDK-11R \$13.00



#QCRA-15 \$19.00



Cat.# QNPV-09E \$19.00



#QNFD-22B \$19.00



#QNFD-22R \$19.00



#QPS-06EB \$19.00

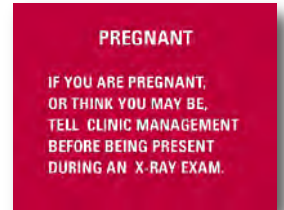

#QPS-06ER \$19.00

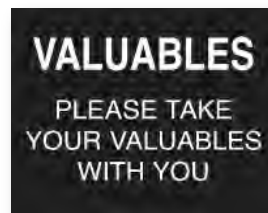

#QVS-10EB \$19.00

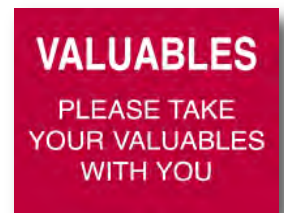

#QVS-10ER \$19.00

Custom Engraved Signs

- Engraved 1/16" thick Rowmark™.
- Stock colors: White letters in Red plate, White letters in Black plate, Red letters in Yellow plate.
- Double-faced tape attached to the back for mounting.
- Letters and numbers only; no symbols.
- Other unusual sizes and styles available for quote.

Example: 5" x 9" = 45 sq. in.

#QSI-48 @ \$32.00



Example Sign

size	cat.#	price
48 sq. inches or less	QSI-48	\$32.00
over 48 sq. in. and up to 144 sq. in.	QSI-144	\$38.00

Radiation Badge Storage Boards

- Provides a central location for all badge related activity.
- Exposure record display area and note clip.
- Accommodates different styles and sizes of badges.
- Ring board is also available for Nuclear Medicine and PET.



NARROW BADGES less than 1" wide



#QFB-10N



#QFB-20N

SQUARE, HEX, WIDE, OBLONG BADGES 1" to 2" wide

cat.#	style	badges	board size	price
QFB-10N	rectangle	10	12" x 5"	\$79.00
QFB-20N	rectangle	20	12" x 9 1/4"	\$87.00
QFB-10W	square/hex	10	12" x 9 1/4"	\$105.00
QFB-20W	square/hex	20	12" x 18"	\$135.00



#QFB-10W



#QFB-20W



I.D. Badge Retractors (NOT for radiation badges!)

- Holds I.D. badge or keys.
- Durable 26" retractable cord.
- Approximately 2" x 2".
- Universal alligator clip.



#QPID-BDG
\$9.90 ea.



#QPID-ELE
\$9.90 ea.



#QPID-MKY
\$9.90 ea.



#QPID-PDA
\$9.90 ea.



#QPID-WCT
\$9.90 ea.

Caliper

Cat.# QCAL-21
\$57.00



- Accurately measure body thickness to be x-rayed.
- Calibrated in both in. and cm.
- Made of durable aluminum.
- 1" wide x 21 1/4" tall w/ 10 1/8" leg.
- Ships @ 1 lb.





**Spin-Lift
Adjustable
Stool
5-Leg**
#QBAS-40
\$249.00



- Solid steel, machined thread screw adjusts height by rotation of the stool cushion.
- Adjustable height: 17¹/₄" to 21³/₄".
- 16" x 4" thick seat cushion.
- 5-leg, die cast aluminum base.
- 23" base provides excellent stability.
- Weight: 21 lbs.; Ships @ 30 lbs.

**Pneumatic
Lift
Stool**
#QBPS-20
\$299.00



- Pneumatic gas cylinder easily adjusts height with convenient under-cushion ring.
- Adjustable height: 17¹/₂" to 22¹/₂".
- 16" x 4" thick seat cushion.
- 5-leg, die cast aluminum base.
- 23" base provides excellent stability.
- Weight: 20 lbs.; Ships @ 30 lbs.

**Spin-Lift
Adjustable
Stool
4-Leg**
#QBAS-30
\$199.00



- Solid steel, machined screw adjusts height by rotation of the stool cushion.
- Adjustable height: 18" to 24¹/₂".
- 14¹/₂" x 4" thick seat cushion.
- 4-leg chrome steel base with footring.
- Weight: 20 lbs.; Ships @ 30 lbs.

Instrument Stand ("Mayo" Stand)

#QBMS-80
\$220.00

- Legs and base are 1" chrome plated steel.
- Adjustable height range: 34" to 53".
- Solid steel, easy-slide extension posts.
- Stainless steel tray is 12" x 19" x 3/4" deep.
- Weight: 12 lbs.; Ships @ 30 lbs.

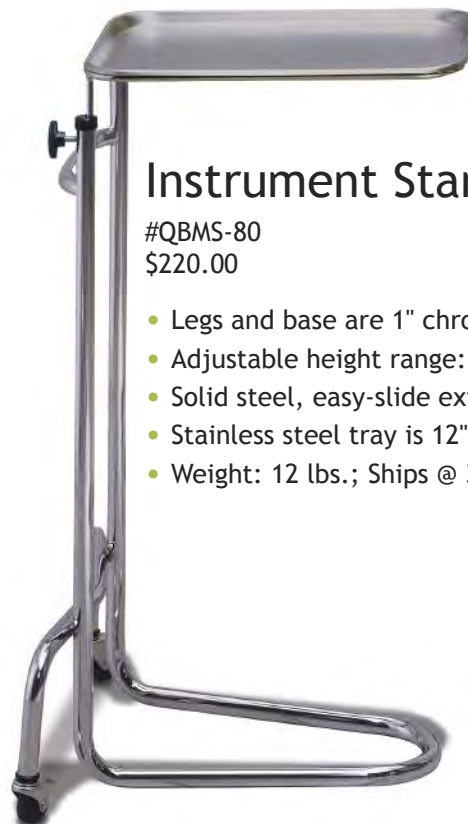

Step Stool with Handrail

#QBSH-65
\$99.00

- All steel 350 lb. capacity.
- Skid resistant black mat.
- 9" high stool with 11" x 13³/₄" top; 34" tall with handrail.
- Handrail is 7/8" dia. chrome-plated tubular steel.
- Easy assembly.
- Shipping weight: stool 8 lbs.; handrail 4 lbs.



Step Stool without Handrail



#QBSS-60
\$67.00

- Similar to stool with BSH-65.
- NO HOLES for handrail.
- Shipping weight: 8 lbs.

IV Stands

- 1" and 7/8" telescoping, chromed steel tubes.
- Adjustable height range: 47" to 84"; Twist Lock.
- Coated, bar steel base with scuff guard tips resists corrosives.
- Two or four rams-horn style IV hooks.
- Weight: 17 lbs.

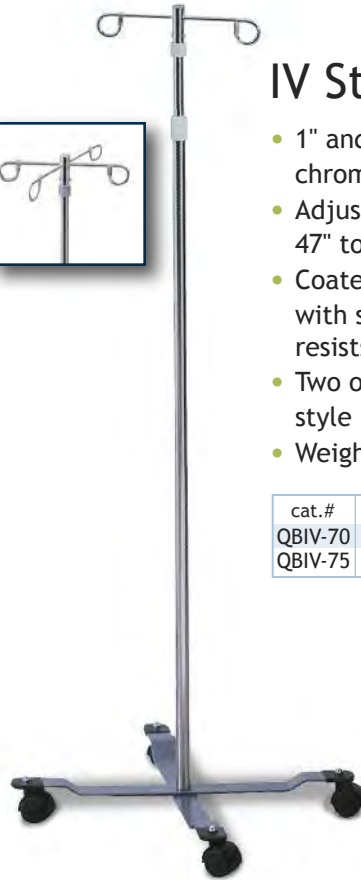

cat.#	description	price
QBIV-70	2-hook iv pole	\$99.00
QBIV-75	4-hook iv pole	\$186.00

Standard Exam Lamp

- Flexible gooseneck arm with 360° adjustable steel shade.
- Adjustable height range: 50" to 74".
- Chrome-plated, weighted steel base.
- Uses one 10 to 40 watt standard bulb (not included).
- Weight: 15 lbs.

Exam Lamp
#QBEL-90
\$155.00

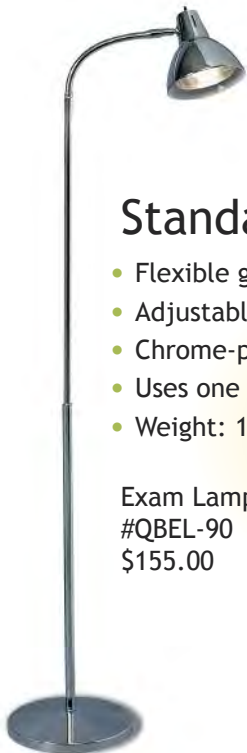

Halogen Exam Lamp

- Flexible gooseneck arm with 540° adjustable head.
- Beige coated, weighted base.
- Uses one high intensity 35 watt halogen lamp.
- 1500 Footcandles @ 24"; 3000° Kelvin.
- Weight: 16 lbs.

Halogen Lamp
#QBEH-91
\$299.00



- Elite markers have the most DURABLE aluminum casing.
- RED for "R" markers and misc. words / BLUE for "L" markers.
- *Green Cat.# means LEAD-FREE!*
- Identifier markers have high-impact polystyrene casing.
- Enhances quality control with fewer repeat exams.
- Provides basic, yet personalized image identification.



Elite Style

#Q1E \$20.00 ea. set
R & L - 5/8"
2 initials - 3/8" or 3 initials - 1/4"
Without initials, order:
#Q4E @ \$12.80/set



#Q7E \$23.00 ea. set
R & L - 1"
2 initials - 3/8" or 3 initials - 1/4"
Without initials, order:
#Q5E @ \$14.70/set



Identifier Style

#QTA-1 \$18.00 ea. set
R & L - 5/8"
2 initials - 3/8" or 3 initials - 1/4"
Without initials, order:
#QTA-4 @ \$11.40/set



#QTA-7 \$22.00 ea. set
R & L - 1"
2 initials - 3/8" or 3 initials - 1/4"
Without initials, order:
#QTA-5 @ \$12.30/set



Position Indicator Markers

Beads Indicate
Patient Position



#QTA-16 \$30.00 ea. set
Identifier Style R & L - 7/8" Position
No initials

#QTA-13 \$30.00 ea. set
Elite Style R & L - 5/8"
2 initials - 3/8" or 3 initials - 1/4"

Personal Touch Shapes



TROPICAL FISH
 #QPT-FRB \$20.00 ea. set
 R & L - 5/8"
 2 initials - 3/8" or 3 initials - 1/4"



SKULLS
 #QPT-SKW \$20.00 ea. set
 R & L - 5/8"
 2 initials - 3/8" or 3 initials - 1/4"



#QTA-002 \$18.00 ea. set
 R & L - 5/8" with 2 initials - 3/8" or 3 initials - 1/4"
 Without initials, order: #QTA-001 @ \$11.40/set



#QA-3 \$7.50 each
 Elite Arrow - 1"



#QTA-A3 \$5.70 each
 Identifier Arrow - 1"

Word Markers

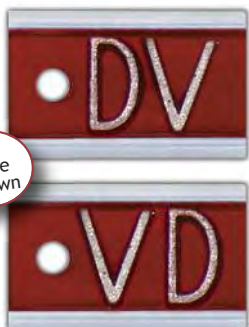

Individual ELITE Words

(aluminum casing)

description	example	cat.# (3/8") price	cat.# (1/2") price
single letter	3	Q2E-Y \$7.50	Q2E-Z \$8.50
2-3 letters	EXT	Q3E-Y \$10.00	Q3E-Z \$12.50
4-5 letters	DMPLO	Q4E-Y \$12.50	Q4E-Z \$15.50
6-7 letters	FLEXION	Q5E-Y \$14.00	Q5E-Z \$17.50
8+ letters	PORTABLE	Q6E-Y \$16.00	Q6E-Z \$20.00

Individual IDENTIFIER Words

(polystyrene plastic casing)

description	example	cat.# (3/8") price	cat.# (1/2") price
single letter	3	Q2TA-Y \$5.50	Q2TA-Z \$6.50
2-3 letters	EXT	Q3TA-Y \$9.50	Q3TA-Z \$10.00
4-5 letters	DMPLO	Q4TA-Y \$11.00	Q4TA-Z \$11.50
6-7 letters	FLEXION	Q5TA-Y \$12.00	Q5TA-Z \$14.00
8-15 / 8-10	PORTABLE	Q6TA-Y \$15.00	Q6TA-Z \$17.00

Wall Boards

- Ideal marker storage.
- Dark walnut grain.
- 3/4" brass hooks.



description	cat.#	price
50 Hook Board	QHK-50	\$129.00
32 Hook Board	QHK-32	\$98.00
16 Hook Board	QHK-16	\$78.00
8 Hook Board	QHK-8	\$69.00

Personal Touch Glitter



WOW! Bright, shiny objects!



RED/BLUE GLITTER
#QPT-GR \$18.00 ea. set
R & L - 5/8"
2 initials - 3/8" or 3 initials - 1/4"



PURPLE GLITTER
#QPT-GP \$18.00 ea. set
R & L - 5/8"
2 initials - 3/8" or 3 initials - 1/4"



YELLOW GLITTER
#QPT-GY \$18.00 ea. set
R & L - 5/8"
2 initials - 3/8" or 3 initials - 1/4"



BURNT SIENNA GLITTER
#QPT-GS \$18.00 ea. set
R & L - 5/8"
2 initials - 3/8" or 3 initials - 1/4"



GREEN GLITTER
#QPT-GG \$18.00 ea. set
R & L - 5/8"
2 initials - 3/8" or 3 initials - 1/4"



ORANGE GLITTER
#QPT-GO \$18.00 ea. set
R & L - 5/8"
2 initials - 3/8" or 3 initials - 1/4"

*Personal Touch
Markers are
LEAD-FREE!*

Personal Touch Tie-Dye



RED/BLUE/PURPLE TIE-DYE
#QPT-TR \$18.00 ea. set
R & L - 5/8"
2 initials - 3/8" or 3 initials - 1/4"



YELLOW/RED/ORANGE TIE-DYE
#QPT-TY \$18.00 ea. set
R & L - 5/8"
2 initials - 3/8" or 3 initials - 1/4"



BLUE/YELLOW/GREEN TIE-DYE
#QPT-TB \$18.00 ea. set
R & L - 5/8"
2 initials - 3/8" or 3 initials - 1/4"

Wafer Thin



#QWTS-1 \$29.00 ea.set
R & L - 3/8" 2 initials - 3/16"
Without initials, order:
#WTS-4 @ \$19.00/set



#QWTS-6B \$29.00 ea.set
R & L - 3/8" 2 initials - 3/16"
Without initials, order:
#WTS-6A @ \$19.00/set



QWTW-A3 (1/2" arrow) \$9.00



Example of QWTW-45 (1/4" letters)

Super Thin for Slim Bucky Clearance

- Perfect for newer equipment (CR, DR, etc.) with very thin bucky clearance.
- Exceptionally thin markers: <math>< 3/32''</math> (2mm).
- Copper filtered for a broad range of KV.
- Elite style and color-coded.

description	cat.#	price
single letter	QWTW-01	\$14.00
2-3 letters	QWTW-23	\$16.00
4-5 letters	QWTW-45	\$18.00
6-7 letters	QWTW-67	\$20.00
8+ letters	QWTW-80	\$22.00

Wafer Thin Words



Stencil Clip

#QXSCP-10
\$15.00 ea.
Plated Steel
Double Clipper.
Stenciled R & L.

Great for Slim Bucky Clearance

Thin Clipper

- Constructed of high strength Kydex™.
- Extra thin profile, double-sided, 1 7/8" wide.
- R and L: 3/4", with or without initials.
- 2 Initials: 3/8"; 3 initials or words: 1/4".



#QCPP-40
\$25.00 ea.
Side View



Sun-Dial Designator Markers

- Denote position or extremity.
- High-density lead characters.
- Actual Size of Sun-Dial is 1 3/4" x 1 3/4".

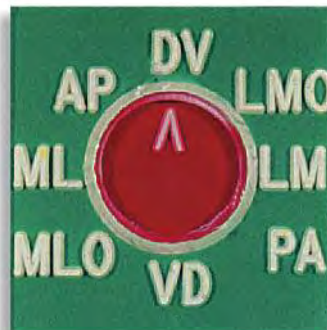

View Sun-Dial
Cat.# QSDV-66 \$70.00



Extremity Sun-Dial
Cat.# QSDV-65 \$70.00

Cover Tab Stickers

- Ideal for coding mismarked or unmarked film.
- Color coded: L-Blue / R-Red.
- Self-adhesive backing.
- 1 1/4" diameter with square for initials.
- Available in greater quantity discounts!

cat.#	1-3 boxes	4-9 boxes	10+boxes
QTAB-R	\$22.00	\$16.00	\$14.00
QTAB-L	\$22.00	\$16.00	\$14.00



250
Stickers
per box



Take Advantage of
Quantity Discounts!

Marking Pens

- Highlights points of interest on a film.
- Wax markers resist smudging, but are not permanent.
- NOT to be used in place of lead markers.
- NOT a legally acceptable marking method.



Example of the
QMPA-19
Assorted Pack

Order each item per number of packs.

Example: 2ea. #QMPY-11
(will be shipped with 10 yellow pens.)

PENS (5 per pack)

color	cat.#	price/pk
Yellow	QMPY-11	\$30.00/pk
Red	QMPR-12	\$30.00/pk
White	QMPW-13	\$30.00/pk
2-Y, 2-R, 1-W	QMPA-19	\$30.00/pk

REFILLS (72 per pack)

color	cat.#	price/pk
Yellow	QMRY-21	\$20.00/pk
Red	QMRR-22	\$20.00/pk
White	QMRW-23	\$20.00/pk

Refills come in pkgs of 72 pieces.

Radi-O-Paque Rulers

45cm

#QCPT-R45
\$175.00/ea.



115cm

#QCPT-R115
\$275.00/ea.



- Sturdy 1 1/4" wide x 1/8" thick.
- High density lead letters.
- Brilliant YELLOW color.
- Spaced in 0.5cm increments.

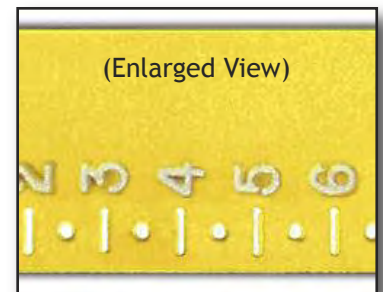

Marker Keeper

- Convenient four-pouch vinyl holder for markers.
- Handy clip attaches the Marker Keeper to belt, lapel, pocket, etc.
- Keeps markers in easy reach for quick retrieval.



color	cat.#	price
Red	QMKR-11	\$9.90
True Blue	QMKB-12	\$9.90
Green	QMKG-13	\$9.90
Yellow	QMKY-14	\$9.90
Clear	QMKC-15	\$9.90
*Assorted (4)	QMKA-19	\$35.00

(*Assorted set does NOT include Clear.)



CHOOSE YOUR
OWN COLOR!

A tool pouch for your markers!

Veri-Thin Legal

Cat.# QXSVL-21 \$48.00 ea.
Holder only. 1¹³/₁₆" x 3¹/₂"

Double aluminum channels;
imprint down and in between
the two channels.

Great for
Bucky Trays!



Cat.# QXSVL-22 \$120.00 set
Complete Set Includes:

- 1ea. holder
- 2ea. A-Z
- 4ea. 0-9
- 2ea. A, E, I, O, U
- 1ea. 36-letter case

(Replacement characters:
3³/₁₆" on 5⁵/₈" plastic tabs.
Reorder #QXTSF-3658)

Perfection

Cat.# QXSVA-11 \$44.00 ea.
Holder only. 1¹/₈" x 3¹/₂"

Single aluminum channel;
imprint above and below
the channel.



Cat.# QXSVA-12 \$99.00 set
Complete Set Includes:

- 1ea. holder
- 2ea. R, L
- 4ea. 0-9
- 1ea. 36-letter case

(Replacement characters:
3³/₁₆" on 5⁵/₈" plastic tabs.
Reorder #QXTSF-3658)

Individual Characters (Flat Face)



Cat.#	Lead/Plastic Size	Price	Comments
QXTSF-3658	3 ³ / ₁₆ " on 5 ⁵ / ₈ "	.79	Fits: Veri-Thin Style Holders
QXTUF-36	3 ³ / ₁₆ "	.49	Unmounted Letter or Number
QXTUF-14	1 ¹ / ₄ "	.49	Unmounted Letter or Number
QXTUF-12	1 ¹ / ₂ "	.59	Unmounted Letter or Number
QXTUF-01	1"	.99	Unmounted R or L only
QXTUA-12	1 ¹ / ₂ "	.79	Unmounted Arrow
QXTUA-01	1"	.99	Unmounted Arrow

Lead Letter Case



Cat.# QXSLC-36
\$40.00

- Injection Molded Box.
- 36 scoop-bottom compartments
(for A-Z and 0-9).
- Side compartment for holder.

Permanent Imprints

- Permanent, engraved facility ID marker.
- Aluminum-backed, high-density 1/4" lead letters.
- Velcro on the back.



Cat.# QPI-2 Two (2) line imprint \$39.00



Cat.# QPI-3 Three (3) line imprint \$49.00

X-Ray Film Copier



#Q195D
\$725.00

EASY! Place the original film and the copy film on the glass. Then, press "expose" and run through any standard processor.

- Compact design uses less counter space; single UV lamp.
- FLAT GLASS contact surface - extremely easy to use.
- Non-rigid, floppy lid contours to film for excellent contact.
- Electronic timer with automatic reset.
- All metal housing.
- 18" w x 15" d x 12" h
- 110 VAC standard
- 1 year warranty (excl. glass & bulbs)
- Shipping weight: 31 lbs.

Copy 14" x 17" Film with NO Moving Parts!



Replacement Glass & Lamps

NOTE: When ordering replacement parts, please include the **Model#** of T-A Unit and the **Brand** of Film you use. This will allow us to send you the correct parts.

description	cat.#	price
Clear Glass for 195D	QGCL-450	\$29.00
UV (black light) Lamp for 195D copier	QBLB195	\$29.00
UV for above copiers using Kodak RA film	QEK-BLB195	\$45.00
UV for above copiers using Konica film	QKON-350BL	\$35.00

Standard Copier Cart

#QUC-70
\$275.00

- Copier transport cart. Also for sponges, linens, accessory items, etc.
- Unassembled.
- 25" x 19" x 30" h.
- Shipping weight: 36 lbs.



Film Bins: Small and Standard

- Allows different types of film to be safely stored in areas frequently "hit" with white light.
- Gas spring automatically keeps light-tight door closed and sealed to eliminate ruined x-ray film.
- All steel construction with texture-black enamel finish.
- Can be mount on a countertop or vertically on a wall.



small film bin
#QMFB-75 \$408.00

- Three inner compartments hold up to 10" x 12" film.
- 12" w x 13" d x 10" h overall.
- Shipping weight: 31 lbs.

standard film bin
#QSFB-85 \$535.00

- Three inner compartments hold up to 14" x 17" film.
- 15 1/2" w x 20" d x 10" h overall.
- Shipping weight: 45 lbs.



Safe-Spot Safelight

- Adjustable swivel & pivot base.
- Safe for high speed film.
- Filter is GBX-2 compatible
- Pull chain switch.
- 15-watt incandescent lamp.
- Shipping weight: 3 lbs.

safe-spot
#QSSP-15
\$179.00



Fluoro-Safelight

- Ceiling or wall mount.
- 15-watt, 18" fluorescent lamp.
- Blue/Green film type filter will not dry or crack with age.
- Pull chain switch and 6 foot power cord.
- Shipping weight: 8 lbs.

fluorescent safelight
single lamp model
#QSL-15 \$225.00



I.D. Cards - Standard

- Standard Cards measure 3" x 5".
- Each card is imprinted with standard legend.
- Each pack contains 1,000 cards.
- Shipped from stock.

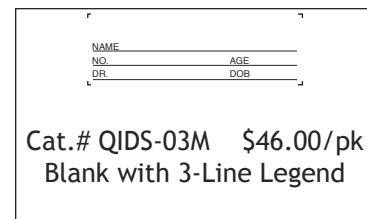
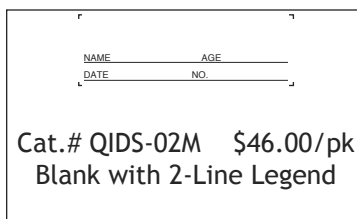

I.D. Cards - Custom

- Custom Cards measure 3" x 5" with 1" x 3" imprint window.
- Each card is imprinted with:
 - Your Custom Imprint (0, 1, 2 or 3 lines);
 - Custom Legend (0, 1, 2 or 3 lines);
 - (if not specified, standard legend will be used).
- Each pack contains 1,000 cards.



Example: Cat.# QIDC-23C

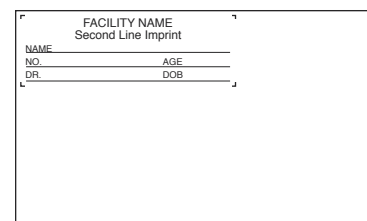

Artwork may not be an exact match to that of other suppliers.

Custom Cards are non-returnable.

If not specified, standard legend will be used.

Example: Cat.# QIDC-32M

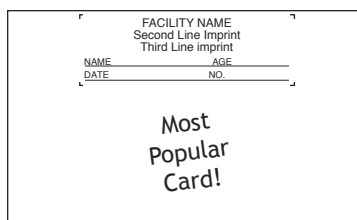

Example: Cat.# QIDC-22D

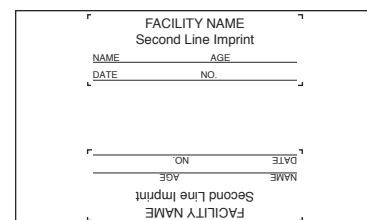

CUSTOM CARD BUILDER

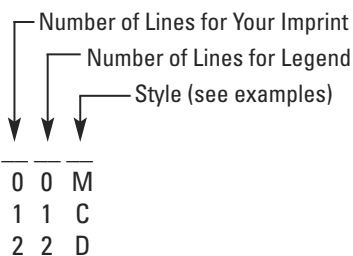

style	imprint location	1000 cards	5000 cards
M	Middle Top	\$55.00/M	\$49.00/M
C	Top Corner	\$55.00/M	\$49.00/M
D	Double Middle	\$63.00/M	\$57.00/M
Q	GE or Kodak (compatible)	\$65.00/M	\$59.00/M

(When ordering, a faxed diagram is most helpful.)

I.D. Printer

Cat.# QIDP-33
\$299.00

Accommodates Middle & Corner Cards



Pin Adapter can be set for use with middle or corner cards.

- Fully automatic exposure for perfect image prints.
- Adjustable exposure timer for most film types.
- Film positioning guides for middle or corner ID cards.
- Durable, all-metal housing.
- Plugs into 110/120 VAC.
- 8" w x 8" d x 3" h, ships @ 6 lbs.

Viewboxes

- Illuminators or "view boxes" are the ideal light source for the proper diagnosis and interpretation of x-ray radiographs.
- High quality, cost effective and can be mounted virtually anywhere.
- Provides the right conditions for efficient film reading.

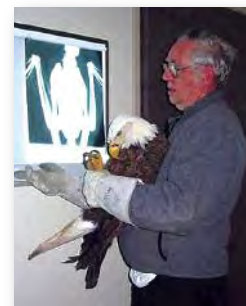

single bank
Cat.# QVBS-10
\$209.00

14" w x 3 1/2" d x 21 3/4" h
Shipping wt: 17 lbs.



double bank
Cat.# QVBD-20
\$399.00

28" w x 3 1/2" d x 21 3/4" h
Shipping wt: 34 lbs.

- Upper and Lower Film Grips.
- Includes two 15-watt fluorescent lamps.
- Stand alone or wall mount.
- 6 foot cord and UL listed.

Special Size Cabinets

- Same specs as the Standard Cabinets on pages 35.
- STACKABLE (secures with nuts & bolts).
- Specify: Base Unit (w/ dustplate) or Stacker (no dustplate). (Base unit is 3" taller than a Stacker.)
- 24" & 48" wide cabinets are available.

Special Sizes ship:

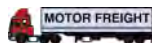

Q632XST with locking DOORS!

Cat.# Q631XST*

Cat.# Q632XST

Cat.# Q633XST

Cat.# Q634XST

Cat.# QDR632XST

36" x 18" x 36"
\$795.00 Ships @ 170 lbs.

Cat.#	Tier	w x d x h (in.)	Ships @	1-4	5-9	10-19	20+
Q631XST	1	36x18x20*	77#	\$222.00	\$215.00	\$213.00	\$208.00
Q632XST	2	36x18x36	115#	\$420.00	\$411.00	\$404.00	\$393.00
Q633XST	3	36x18x52	165#	\$549.00	\$536.00	\$524.00	\$514.00
Q634XST	4	36x18x68	212#	\$645.00	\$633.00	\$619.00	\$607.00

***IMPORTANT NOTE about Bases and Stackers:**

All units are shipped as Base Units which include a 3" dustplate, with the exception of the Q621XST, Q631XST, Q641XST single-tier units, which are shipped as Stackers at 17" tall without a dustplate, unless a Base Unit at 20" tall is specified.

- Only available on the Q632XST.
- Flush-mounted paddle handles.
- Locks offer attractive security.
- Heavy duty construction.

Stackable Cabinets

Ideal for facilities with limited receiving areas

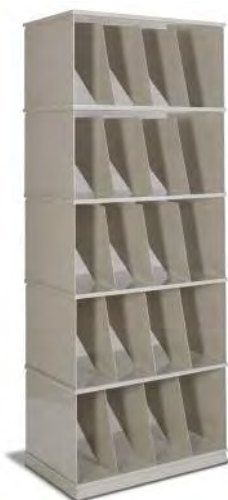

Order only the size you need and the components you want.
Easy assembly: Stack the rack and file your films & files.

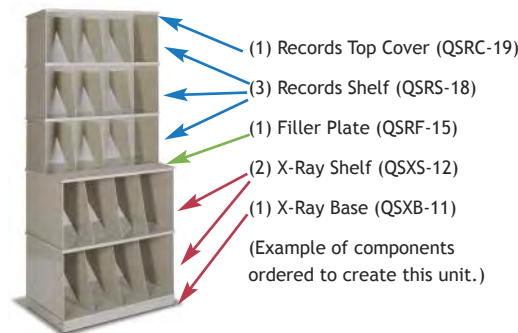

- No tools, no pins, and no hardware required.
- Each component is individually boxed for easy unloading from UPS or motor carrier.
- Easy handling and set-up with minimal staff.
- UPS shippable! (Bulk orders could go motor freight to save shipping costs).

cat.#	description	price
QSXC-13	X-Ray Top Cover	\$48.00
QSXS-12	X-Ray Shelf (1-tier)	\$184.00
QSXB-11	X-Ray Base	\$87.00
QSXD-14	X-Ray Door (1-tier)	\$357.00

cat.#	description	price
QSRC-19	Records Top Cover	\$48.00
QSRS-18	Records Shelf (1-tier)	\$158.00
QSRB-17	Records Base	\$80.00

cat.#	description	price
QSRF-15	X-Ray-to-Records Filler	\$28.00

x-ray stackables (per tier)

- Holds folders for 14x17 film.
- Shelf: 32"w x 19"d x 16 1/2"h., 38(70)lbs.
- Shelf vertical clearance: 15 1/8".
- 2" tall Base: 7 lbs.

records stackables (per tier)

- Holds medical records & mammo film.
- Shelf: 32"w x 12"d x 12 5/8"h., 23 lbs.
- Shelf vertical clearance: 11 1/4".
- 2" tall Base: 6 lbs.

filler plate

- When a record-size shelf is placed on top of an x-ray-size shelf, this results in a 7" gap. This filler plate "fills the gap" to create a complete shelf where the two sizes meet.
- Stackables are available in four colors: putty, twilight, black, blue.

Techno-Tuff™ X-Ray Filing Cabinets

Fully assembled, tough, and versatile.



#Q608A



#Q618A



#Q628A



Q618A with LOCKING DOORS!

#QDR618A 36" x 20" x 84"
\$1175.00 Ships @ 288 lbs.

- Aesthetic design is suitable for outer offices and file rooms.
- All steel nut & bolt construction offers maximum strength.
- Solid back and side panels for security.
- Available in eight (8) colors (see color chart).
- Narrow compartments: dividers are 6" apart.
- 15³/₈" vertical shelf clearance.
- 12-gauge corner posts for maximum vertical strength.
- Full height dividers add vertical strength and stability.

cat.#	w x d x h (in.)	ships @	1-4	5-9	10-19	20+
Q608A	24x18x84	188#	\$589.00	\$583.00	\$577.00	\$567.00
Q618A	36x18x84	238#	\$699.00	\$689.00	\$679.00	\$659.00
Q628A	48x18x84	295#	\$932.00	\$923.00	\$904.00	\$885.00

Fully Assembled Records Cabinets



QMMU-4881 shown

- Specifically designed for 10" x 12" records.
- Seven shelves (six openings).
- 3 dividers per shelf on 36" unit, 4 dividers per shelf on 48" unit.
- All steel nut-bolt construction.
- Assembled and ready to use.
- Solid back and side panels.
- 11³/₄" vertical shelf clearance.



Cat.#	w x d x h (in.)	Ships @	price
QMMU-3681	36x12x81	162#	\$605.00
QMMU-4881	48x12x81	198#	\$735.00

Paint Selection Chart for Cabinets & Carts

Standard Paint	Custom Paint (non-returnable)
Almond (default)	Black
Putty	White
Twilight	Blue
Gray	Rose

SPECIAL NOTE ABOUT MOTOR FREIGHT:

Please provide information about your receiving area to determine standard or special delivery requirements. Motor freight companies will not unload shipments to accounts who do not have a commercial height receiving dock. In most other circumstances, however, special arrangements can be made available at a reasonable extra freight charge.

Wall Bin

- Extremely durable steel and polycarbonate construction.
- Will hold CR plates, cassettes, film jackets, and caddies.
- Includes a convenient message clip.
- Opening is 22" w x 5" d x 14" h.



#Q80AC
\$299.00

Overall size:
22" w x 5³/₈" d x 22" h
Shipping weight:
25 lbs.

Chart, Folder or Film Holder

- Steel backboard and base (open sides).
- Smoked clear polycarbonate front.
- Includes a convenient message clip.
- Rubber mat in base to keep folders from sliding.
- Used for charts, folders, caddies, film, etc.



#Q89AC
\$111.00/ea.

14" w x 3" d x 12" h.
Shipping: 8 lbs.

Wall Mounted Organizers

cat.#	pockets	Width x Height	Price
QPWR-5	5	21 ¹ / ₂ " x 27 ¹ / ₂ "	\$ 99.00
QPWR-10	10	21 ¹ / ₂ " x 43"	\$169.00
QPWR-15	15	21 ¹ / ₂ " x 57 ¹ / ₂ "	\$219.00

- Economical in-process film or file sorting.
- Interior width clearance: 20".
- Mounts to the wall.
- Seams and pockets are reinforced and tear resistant.
- Each pocket can hold multiple folders.
- Available in blue (default), red, black, green, and yellow.



E-Z X-Ray Storage Boxes

- Efficiently store and archive x-ray film files.
- Strong and durable, stacks without crushing.
- One piece, easy fold assembly, incl. handles.

Horizontal Filing



Vertical Filing

Cat.# QETX-70
(15 boxes per case)

# cases	price per case
1-3	\$129.00
4-7	\$124.00
8-15	\$119.00
16-49	\$114.00
50+	\$109.00



- Accommodates files and film up to 14" x 17".
- Lid opens up or forward.
- Sized for OSHA lift load capacity.
- Each box O.D.: 6¹/₄" x 16" x 19¹/₂".
- Ships as 30 lbs. per case.

(6 cases or less via UPS / 7+ cases via motor freight.)

Multi-use Portfolio



#QFPM-22 \$90.00

- Perfect for large files or film.
- Clear front pouch for notes, chain-of-custody, cd/dvd, etc.
- Three inner pouches to separate items and files.
- Durable, reinforced vinyl.
- 3-point hook & loop closure and dual handles.
- Comes in black (default), blue, red, green or yellow.
- Overall size: 22" x 17".
- Shipping weight: 3 lbs.



Features three inside pouches and a clear front pouch!



- Reinforced wear points.
- Carts have padded bar-style handles.
- All steel construction with a durable powder coat finish.

- Sturdy 4" plate casters for easy handling.
- Rubber mat inside each compartment.

Small Activity Cart



Cat.# Q46AC
\$715.00

Two compartments:
8" w x 24" l x 13" deep.

Cat.# Q45AC
\$715.00

Four compartments:
6" w x 16" l x 13" deep.



- Nominal size: 24" x 16" x 36" h.
- Shipping weight: 85 lbs.

Tall Cassette Cart



Cat.# QCRM-38
\$728.00

- Eight 6" wide compartments @ 16³/₄" vertical clearance.
- Nominal size: 24" x 18" x 42¹/₂" h.
- Shipping weight: 120 lbs.



Paint Color Chart is on p. 35.

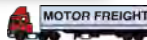

Mini Cassette Cart



Cat.# QCRM-24
\$680.00

- Four 6" wide compartments @ 16³/₄" vert. clearance.
- Nominal size: 24" x 18" x 36" h.
- Shipping weight: 95 lbs.

Slim Line Two-Tier

#QSL-1
\$850.00

- 14-gauge welded steel.
- Two dividers per slanted shelf on 6¹/₂" centers.
- Lower divided shelf has a 15³/₄" vertical clearance.
- 5" plate casters (2 locking).
- Nominal size: 20" w x 17" d x 49" h.
- Shipping weight: 141 lbs.



Multiple Plate/Cassette Rack

Cat.# QCRU-20
\$559.00

- Keeps CR-plates or cassettes clean and organized in four compartments.
- Ideal in tight space.
- Shipping wt: 43 lbs.



- Allows handling of files without damage to film or jacket.
- Heavy gauge vinyl welded together with heat-seal construction.
- Keeps records and film in one convenient location.
- Sealed chipboard insert for rigidity.



Standard Organizers

- Ideal for transport / retrieval protection.
- 2-pocket design for files and jackets.
- Holds up to 14" x 17" film.
- Available in ten (10) colors.
- Cardboard insert for rigid construction.*
- Aids in increased filing efficiency.
- Overall size: 21" x 14 1/2".

cat.#	color	qty./ctn	1-4 ctns	5-9 ctns	10-19 ctns	20+ ctns
Q800	True Blue	20	\$136.00	\$129.00	\$124.00	\$116.00
Q810	Red	20	\$136.00	\$129.00	\$124.00	\$116.00
Q820	Yellow	20	\$136.00	\$129.00	\$124.00	\$116.00
Q830	Green	20	\$136.00	\$129.00	\$124.00	\$116.00
Q840	Purple	20	\$136.00	\$129.00	\$124.00	\$116.00
Q850*	Clear*	20	\$136.00	\$129.00	\$124.00	\$116.00
Q860	Teal	20	\$136.00	\$129.00	\$124.00	\$116.00
Q870	Maroon	20	\$136.00	\$129.00	\$124.00	\$116.00
Q880	Royal Blue	20	\$136.00	\$129.00	\$124.00	\$116.00
Q890	Orange	20	\$136.00	\$129.00	\$124.00	\$116.00

*(CLEAR caddies are flexible and do NOT have cardboard inserts.)

Negative Preservers

- Available in three sizes to accommodate all films.
- All include stock copy lines for: file number, name, date, doctor and remarks.
- Made of 32lb. gold kraft stock.
- Thumbcut for easy access to films.
- Open end (opens along short side edge).
- Red and green available in large size, upon request.

cat.#	size	qty./ctn	wt./ctn	1-7 ctns	8-14 ctns	15+ ctns
QJNS-OEK	8.5 x 10.5	500	25#	\$115.00	\$112.00	\$107.00
QJNM-OEK	10.5 x 12.5	500	25#	\$139.00	\$134.00	\$128.00
QJNL-OEK	14.5 x 17.5	250	22#	\$88.00	\$85.00	\$82.00

- With 1" Expansion Gusset

cat.#	size	qty./ctn	wt./ctn	1-7 ctns	8-14 ctns	15+ ctns
QJNL-OEX	14.5 x 17.5	100	15#	\$232.00	\$225.00	\$217.00



Standard X-Ray Film Jacket



- Single pocket x-ray jacket made of 11pt manila stock.
- Non color-coded (see sticker styles and colors).
- Size: 14¹/₂" x 18¹/₄", including ³/₄" scored self expansion.
- Black ink copy includes blocks for color-code labels and black loan indicator.
- Offset double thumbcut for easy access to contents.
- Opens along upper edge.

cat.#	qty./ctn	wt./ctn	1-9 ctns	10-24 ctns	25+ ctns
QJLJ-SPS	100	22#	\$83.00	\$80.00	\$76.00

Color-Code Labels

- Permanent adhesive with release coated paper backing.
- Superior flexibility for long life.
- Other color systems available.

Digit Color

0	red
1	gray
2	blue
3	orange
4	purple
5	black
6	yellow
7	brown
8	pink
9	green

(shown actual size: 1³/₄" x 1¹/₂")

12 12

small year labels

cat.#	year/color	qty./ctn	1-9 ctns	10-24 ctns	25+ ctns
QJLS-Y11	11/gray	1000/rl	\$12.60	\$10.50	\$8.40
QJLS-Y12	12/blue	1000/rl	\$12.60	\$10.50	\$8.40
QJLS-Y13	13/orange	1000/rl	\$12.60	\$10.50	\$8.40
QJLS-Y14	14/purple	1000/rl	\$12.60	\$10.50	\$8.40

Cardboard Insert Mailers

- Available in two sizes.
- Made of 32lb. brown kraft stock.
- Open end, string & button closure.
- Chipboard insert for rigidity.
- Printed with bold black stock copy.

cat.#	size (inches)	qty./ctn	wt./ctn	1-9 ctns	10-19 ctns	20+ ctns
QJMM-SBC	11 x 13	50	8#	\$53.00	\$51.00	\$49.00
QJML-SBC	15 x 18	50	12#	\$60.00	\$58.00	\$55.00



CD/DVD Sleeves

- Standard 5" x 5" CD/DVD protectio sleeves.
- Made of 60lb. white offset paper stock.
- Window made of clear polyester.

cat.#	qty./ctn	wt./ctn	1-7 ctns	8-14 ctns	15+ ctns
QJCD-CSW	1000	14#	\$115.00	\$109.00	\$104.00



CD/DVD Mailers

- Features self-adhesive closure and tear-tape tab opening.
- Made of 20pt. coated white board.
- Economy; no liner.

cat.#	qty./ctn	wt./ctn	1-7 ctns	8-14 ctns	15+ ctns
QJCD-CDX	250	15#	\$83.00	\$78.00	\$73.00

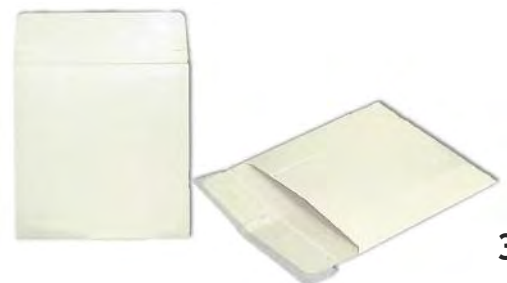

FUSION

BLENDING BODY, WORK & MOTION

Sit-to-Stand Height Adjustable Ergonomic Desks

The blueprint to comfort and efficiency begins with a design that fits your needs. Techno-Aide's FUSION line of ergonomic furniture solutions features:

- electric and manual height adjustable desks
- expanded range of standard configurations
- customized work surfaces
- design services to optimize your space



LINEAR DESKS (straight back)

Cat.# ZLCU • linear contour front / undivided surface / 60"-to-96" long x 36" deep.

Cat.# ZLCD • linear contour front / divided surface / 60"-to-96" long x 36" deep.

Cat.# ZLSU • linear straight front / undivided surface / 60"-to-96" long x 30"-or-36" deep.

Cat.# ZLSD • linear straight front / divided surface / 60"-to-96" long x 30" deep.

Cat.# ZLMS • linear multi-system / undivided surface / 60"-to-96" long x 36" deep.

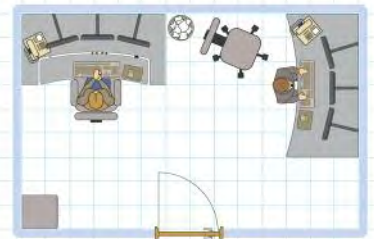

WEDGE DESKS

Cat.# ZWCF • corner wedge contour front / divided surface / 60"-to-72" from corner outward x 90" front span.

Cat.# ZWWV • linear back, wedge wave front / undivided surface / 78" long x 33" deep.

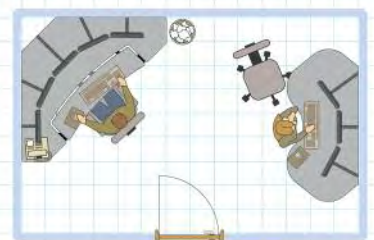

WORK SURFACE:

- Laminated solid surface with high endurance PVC edging.
- Top is supported by a heavy duty frame that offers generous leg room.
- Models with the Divided Surface Lift (DSL) have 11³/₄" adjustment range: 6" above and 5³/₄" below the work surface with +9/-15° tilt.
- Custom sizes available; please call for quote.
- *A list of color choices is on page 9.*

ELECTRIC BASE:

- Includes 3-position programmable controller.
- 27" adjustment range: 24.5" - 51.5" (at 1.7"/sec).
- Load capacity: 300 lbs.
- Requires less than 3amps of power.
- Locking casters available.
- Limited Lifetime Warranty.



CORNER DESKS

Cat.# ZCVU • corner view / undivided surface / right or left extension: 60"-to-96" long x 30" deep.

Cat.# ZCVD • corner view / divided surface / right or left extension: 60"-to-96" long x 30" deep.

Cat.# ZMPE • corner multi-purpose extension / undivided surface / back desk: 60"-to-96" long x 30" deep / right or left extension: 48"-to-72" long x 24" deep.

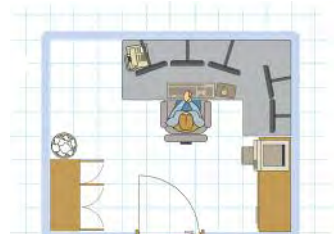
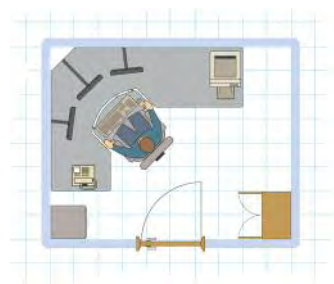

DOUBLE DRIVE DESKS (rear and front surfaces have separate motors and controls)

Cat.# ZDCF • linear contour front / split double-drive surface / 72" long x 36" deep.

Cat.# ZDSF • linear straight front / split double-drive surface / 48"-to-96" long x 30" deep.

Cat.# ZDMS • linear multi-system / split double-drive surface / 60"-to-96" long x 36" deep.

Cat.# ZDME • corner multi-purpose extension / split double-drive surface / back desk: 60"-to-96" long x 30" deep / right or left extension: 48"-to-72" long x 24" deep.

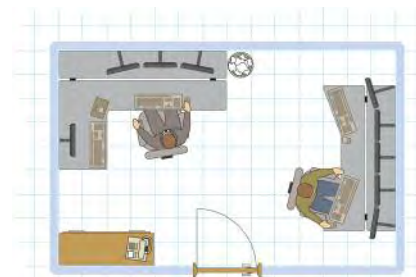



Single Monitor Fixed Post

#ZEMS-SF21
\$295.00

- 5" to 24" double joint extension arm.
- 17" height range.
- Monitor weight capacity: 25-lb. max.
- Pivot and rotate monitor.
- Clamp mount.

Single Monitor Articulating Arm

#ZEMS-SA21
\$350.00

- Articulating gas spring directional adjustment.
- 13" height range.
- Monitor weight range: 7-lb. min. / 20-lb. max.
- Pivot and rotate monitor.
- Clamp mount.



Dual Monitor Fixed Post

#ZEMS-SF22
\$395.00

Double capacity of ZEMS-SF21 shown above.

Dual Monitor Articulating Arm

#ZEMS-SA22
\$520.00

Double capacity of ZEMS-SA21 shown above.



Triple Monitor Fixed Post

#ZEMS-SF23
\$495.00

Triple capacity of ZEMS-SF21 shown above.

Articulating Laptop Holder

#ZELA-SALH
\$470.00

Laptop Mount with ZEMS-SA21 shown above.



Economy Articulating Arm

#ZEMS-SV21
\$280.00

- Articulating gas spring directional adjustment.
- 13" height range.
- Monitor weight range: 6-lb. min. / 18-lb. max.
- Pivot and rotate monitor.
- Clamp mount.

Heavy-Duty Articulating Arm

#ZEMS-HDA1
\$475.00

- Articulating gas spring directional adjustment.
- 4" to 24" arm extension.
- Monitor weight range: 17-lb. min. / 33-lb. max.
- Pivot and rotate monitor.
- Clamp mount.



Mobile & Wall Mount Workstations

- Double-jointed extendable arms.
- Track-slide height adjustment.
- Ask about our *pre-assembly program!*

MOBILE WORKSTATION:
 1-intergrated workstation
 1-steel post (total ht.: 67")
 1-stablizer H-base
 1-cable channel
 4-locking casters

WALL MOUNT WORKSTATION:
 1-31½" wall mount vertical track
 1-extension arm keyboard tray
 1-75mm/100mm VESA extend-mount
 [Models with CPU Holder include an additional track for 63" total height.]



Single View Workstation

MOBILE
 #ZTMW-ES21
 \$1145.00



WALL MOUNT
 #ZEVW-ES21
 \$700.00



Dual View Workstation

MOBILE
 #ZTMW-ES22
 \$1270.00



WALL MOUNT
 #ZEVW-ES22
 \$850.00



Single View Workstation w/CPU

MOBILE
 #ZTMW-ET31
 \$1355.00



WALL MOUNT
 #ZEVW-ET31
 \$960.00



Dual View Workstation w/CPU

MOBILE
 #ZTMW-ET32
 \$1495.00



WALL MOUNT
 #ZEVW-ET32
 \$1120.00

Electronic equipment shown is not included.

FLIP-UP Wall Mount

#ZEVW-SS21 \$490.00

- All components can be easily relocated along the vertical support post.
- Wall Mount System includes:
 - 1-31.5" wall mount vertical track
 - 1-FLIP-UP Keyboard tray
 - 1-75mm/100mm VESA swivel mount
 - All components slide independently



Keyboard tray folds up and out of the way!



FLIP-UP Wall Mount w/CPU

#ZEVW-TS31 \$830.00

Same as above, but includes additional 31.5" track (for 63" total) and CPU holder.

wall mount kiosks

Laptop Articulating Arm



Cat.# ZELA-SALH
\$440.00

- Articulating gas spring directional adjustment.
- 24" extension range.
- 13" height range.
- Laptop weight range: 6-lb. min./18-lb. max.
- Pivot/tilt/rotate bracket.
- Clamp mount.

Extension Articulating Arm



Cat.# ZELA-SFLH
\$395.00

- Double joint extension arm.
- 5"-24" extension range.
- 17" height range.
- Laptop weight capacity: 16-lb. max.
- Pivot/tilt/rotate bracket.
- Clamp mount.

Laptop/Monitor Combo Arm



Cat.# ZELA-VLMC
\$630.00

Similar to the ZELA-SALH Laptop Arm shown above, but includes brackets to mount both a laptop and a monitor on independent arms at the same time.

Wall Mount Laptop Holder



Cat.# ZELA-WALT
\$550.00

- 24" vertical wall track.
- Unique shuttle provides 7 $\frac{1}{2}$ " of easy-touch arm height adjustment.
- Fits laptops with a diagonal measurement from 12"-15 $\frac{1}{2}$ ".
- 3-piece extension arm.
- Adjustable brackets hold laptop firmly in place.
- Universal laptop clamps.

Go-Anywhere Laptop Cart

Cat.# ZBLM-MC
\$395.00



LAPTOP CART (gas spring height adjustment):

- Portable stand with ample room for a keyboard or laptop.
- Easily moves where you need to work.
- Footring controls a pneumatic gas spring that raises the top from 20" to 30".
- Includes angled laptop shelf and two removable mousepad/cupholders.
- Top is light gray with black vinyl wrist rest.
- Frame is black powder coated steel.
- Ships UPS/FedEx @ 38#.

Pop-Up Laptop Cart

Cat.# ZBLM-PB
(black)
\$250.00

Cat.# ZBLM-PM
(mahogany)
\$250.00



LAPTOP CART (gas spring height adjustment):

- Portable stand with ample room for a keyboard or laptop.
- Easily moves where you need to work.
- Hand lever controls a pneumatic gas spring that raises the top from 21 $\frac{1}{4}$ " to 31 $\frac{1}{4}$ ".
- Top is available in black or mahogany laminate.
- 5-star base with easy rolling 2" casters.
- Ships UPS/FedEx @ 23#.

Universal CPU Holder

#ZEDA-CPUU \$165.00

- Stores CPU underneath work surface.
- Features easy-access slide and swivel action.
- Adjustable width: 2 1/2" to 8 1/4".
- Adjustable height: 13" to 21".
- 100 lb weight capacity.

Clamp CPU Holder

#ZKUH-CL \$150.00 (standard non-locking)

#ZKUH-LK \$160.00 (with security lock)

- Save valuable workspace and protect CPU.
- Fits CPU: 15"-23"h x 4 3/4"-8 1/2"w x any depth.
- 18" track and 360° swivel for easy access.
- Securely clamps CPU into position.
- 75 lb weight capacity.

Mobile CPU Caddy

#ZEDA-CPUC \$89.00

- Stores CPU above the floor for easy access.
- Fits any CPU within a 3 1/2"-8 3/4" width.



Universal CPU Holder



standard non-locking



CPU Caddy

Clamp CPU Holder



with security lock

(CPUs not included)

Lift and Lock Keyboard Support

- Lift and Lock height adjustment.
- 7" height adjustment on 21" track: 2 1/2" above and 4 1/2" below the surface.
- 15° +/- tilt and 360-degree swivel.
- Mouse surface can be mounted on either side.
- Integrated gel palm rest.



#ZKKL-EX
\$295.00

Keyboard Supports are not necessary on desks with the SSL. Keyboard not included.

Cupholder

#ZFDA-CP \$65.00

- Desk edge clamp mount.
- Holds cups, mugs, and square bottles!
- All-metal construction.



Combo Copy Holder and Telephone Support

#ZFDA-CS \$125.00

- Desk edge clamp mount.
- Flexible gooseneck arm support.
- Adjust flat for phones.
- Adjust upright for papers.
- Lower lip keeps booklets open.



Flexi-Lamp

#ZKDL-FFL \$170.00

- 20-watt halogen lamp.
- 25" gooseneck arm conveniently allows lamp to be adjusted into virtually any position for direct or ambient light.

Shines UP or DOWN for Ambient or Direct Light!



Flexi-Lamp

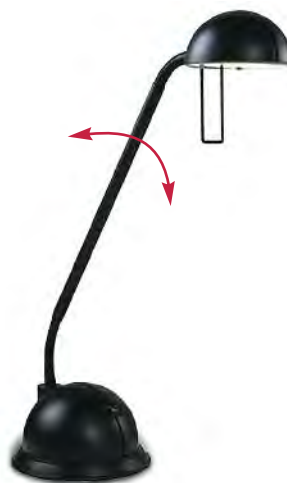

Hi-Lo Lamp

Hi-Lo Lamp

#ZKDL-FHL \$155.00

- Three stage rocker switch (hi/low/off).
- 50-watt halogen lamp.
- Unique parabolic shade.
- Color correct lighting.

Comfort Seating



Trophy™



Derby™

Trophy™

- Stylish and comfortable.
- Mid-back height: 21½" with height adjustable arms.
- Contoured seat & back with resilient molded foam.
- Swivel/tilt: pneumatic height adjustment, internal back height adjustment, 360° swivel, seat & back tilt as one unit, heavy-duty tension adjustment.

Derby™

- Popular and affordable quality.
- Mid-back height: 20" with height adjustable arms.
- Outer back shell of high impact black polypropylene.
- Swivel/tilt: pneumatic height adjustment, internal back height adjustment, 360° swivel, seat & back tilt as one unit, heavy-duty tension adjustment.

cat.#	model	fabric	price each
ZSTR-MS2	Trophy	Grade 2	\$810.00
ZSTR-MS4	Trophy	Grade 4	\$875.00
ZSTR-MSL	Trophy	Leather	\$1270.00
ZSDE-MS2	Derby	Grade 2	\$595.00
ZSDE-MS4	Derby	Grade 4	\$630.00



Ergo Extra

#ZBCH-EXB
\$670.00

- Contouring mesh back.
- Adjustable lumbar support.
- Adjustable headrest.
- Pneumatic lift.
- Swivel/tilt tension.
- Seat fwd/bwd glide.
- Independent seat/back tilt.
- Adjustable arms.
- Five-star caster base.
- 2-year limited warranty.
- (Black only) Ships @ 49#.

Ergonomic Chair with Extra Lumbar Support!



Champion™ High-Tech Comfort



mesh back shown

Champion™

- Hyperbolic mesh contours to body types; reduces fatigue.
- Innovative shell creates flex zones to support user's back.
- Mesh back: interwoven mono/multi-filament Elastomer.
- Upholstered back: full back pad replaces mesh.
- Overall height: 34¾"-41¼"; back height adjustment of 2½".
- Button adjustable arms with 3" height range.
- Multi-task: same as swivel/tilt, PLUS: forward tilt with tilt lock, back adjusts independently of seat with infinite lock.
- Warranty: foam & fabric 5-years/all other parts lifetime.

cat.#	style	fabric	price
ZSCH-MM2	Champion	Mesh Back w/ Grade 2 seat	\$995.00
ZSCH-MM4	Champion	Mesh Back w/ Grade 4 seat	\$1050.00
ZSCH-MML	Champion	Mesh Back w/ Leather seat	\$1195.00
ZSCH-UM2	Champion	Upholstered w/ Grade 2	\$995.00
ZSCH-UM4	Champion	Upholstered w/ Grade 4	\$1090.00
ZSCH-UML	Champion	Upholstered w/ Leather	\$1295.00



Derby™ Stool



Universal Stool



Ribbon™

Derby™ Stool

- Popular and affordable quality.
- Counter height comfort work solution; small back.
- Overall height: 36½"-49½"; seat height: 20"-31".
- Choose upholstery option.

Universal Stool

- Self-skinned urethane seat & back (black only).
- Pneumatic lift adjusts seat from 22" to 32".
- Height adjustable footring / height adjustable back.

Ribbon™ Side Seating

- 7/8" black tubular steel frame.
- Can be stacked for easy storage.
- Affordable (four chair minimum order).

(Warranty: foam & fabric 5-years; other parts lifetime.)

cat.#	model	fabric	price each
ZSDS-S12	Derby Stool	Grade 2	\$695.00
ZSDS-S14	Derby Stool	Grade 4	\$725.00
ZBCH-USB	Unniversal Stool	Urethane	\$299.00
ZSRB-SN2	Ribbon(min.4)	Grade 2	\$429.00
ZSRB-SN4	Ribbon(min.4)	Grade 4	\$459.00

Fabrics below

Utility Seating

Height Adjustable Desk Laminate and Color Selection



- Example: #ZDCF-E7236
- Desktop: mahogany
 - Base: black
 - Trim: black

Desktop Surface Laminate

Base Support Paint Color

Desktop Edge Band



Seating Upholstery Selection

(Vinyl and other fabrics are available.)



- Example: #ZSDE-MS2
 Upholstery: garnet

Grade 2 Fabric

Grade 4 Fabric

Leather





EZ-Riter™ Dry-Erase Board

- Ideal for planning, scheduling, messages, diagrams, etc.
- Subtle silver GRID, visible only up close, enables easy line and chart drawing.
- PVC coated steel provides exceptional dry-erase surface.
- Magnetic sheet is laminated to moisture resistant 1/4" MDF.
- Full length marker tray comes with plastic end caps.
- Anodized aluminum frame comes with plastic corner caps.
- Includes one set of dry-erase markers.
- Crating and removable polyfilm coating assures safe delivery.
- Ten-Year Warranty.

Dry Erase Markers

- Cat.# QBDE-4M \$9.90
- Optimized for best results.
 - Set of 4 (R,B,G,Blk).



Dry Eraser

- Cat.# QBDE-ER \$9.90
- Gives clean, dust-free finish.



cat.#	h x l	ships @	price
QZDWM-DE48	33 ³ / ₄ " x 48"	20#	\$195.00
QZDWM-DE72	4' x 72"	48#	\$295.00
QZDWM-DE96	4' x 96"	60#	\$395.00

Rolling Organizer

Cat.# QBRO-09
\$455.00

- Heavy-duty metal frame stands up to daily use.
- Includes nine (9) tubs that measure 12³/₈" x 15¹/₂" x 6"d.
- Side panels are dry-erase surface for writing notes, tasks, etc.
- Include four swivel casters (two are locking).
- Overall size: 40¹/₂"w x 16¹/₂"d x 38"h.
- Some assembly required.
- Ships @ 35#.



Mobile Magazine Rack

Cat.# QBMR-02
\$325.00

- Heavy-duty metal frame stands up to daily use.
- Twenty (20) slots per side.
- Bottom tray holds odd sized items.
- Include four swivel casters (two are locking).
- Overall size: 26"w x 19³/₄"d x 51¹/₄"h.
- Some assembly required.
- Ships @ 45#.

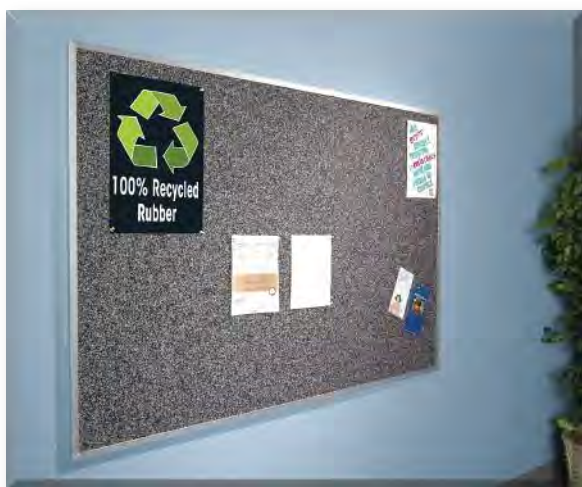
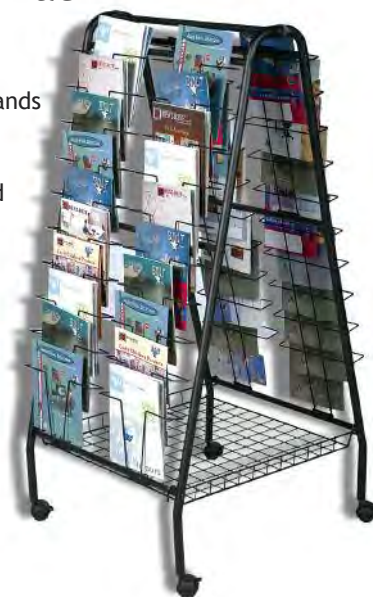

Rubber-Tak™ Bulletin Board

- Ideal for reports, messages, displays, etc.
- Manufactured from high-density 100% recycled rubber.
- Unmatched durability and resiliency.
- Longer lasting than cork; self-healing and non-porous.
- Textured surface will not show pinholes for years of service.
- Resists moisture, mold, mildew, bacteria and chemicals.
- Neutral black/gray colors are framed in anodized aluminum.
- Stain resistant and easy to maintain.

cat.#	h x l	ships @	price
QZDWM-BB72	4' x 72"	66#	\$295.00
QZDWM-BB96	4' x 96"	88#	\$395.00

A

Animal Immobilizers10-15
 Animal Transfer Carriers20
 Apparel, Lead Protective3-5
 Aprons, Lead Protective3
 Apron Racks7

B

Badge Boards23
 Barriers, Mobile Lead16
 Blanket, lead.....5
 Blockers, lead17
 Boxes, storage36
 Bulletin Board48

C

Cabinets:
 Medical Records34-35
 Stackable34
 X-Ray File35
 Caliper23
 Carts:
 Cassette/CR-Plate.....37
 Copier32
 Top Loading.....37
 Cassette/CR:
 Blockers17
 Covers.....19
 Equine19
 Holders.....18-19
 Mobile Stand19
 CD Mailers39
 CD Sleeves.....39
 Chairs46-47
 Chart Holder36
 Copier, x-ray film32
 Covers:
 Cassette/CR-Plate.....19
 Immobilizer13
 Sponge13
 CR Plate Holder:
 Equine19
 Lateral.....18
 Mobile18-19

D

Desks.....40-41
 Desk Accessories.....45
 Disinfectant8, 21
 Dry-Erase Board48
 Duplicator, x-ray film32

E

Equine Cassette/CR Holder19
 Extremity Rulers30

F

Fabric Selection (aprons).....9
 Film Bins.....32
 Film Jacket.....39
 Folders.....39

G

Germicide.....21
 Glasses, lead protective6
 Gloves, lead5

I

I.D. Badge Retractor23
 I.D. Printer.....33
 I.D. Printer Cards33
 Illuminators.....33
 Immobilizers.....10-15
 Immobilizer Covers.....13
 Instrument Stand24
 IV Poles25

L

Labels39
 Lamp, Desk45
 Lamp, Exam.....25
 Laptop Cart44
 Lateral Cassette Holders.....18
 Lead Glasses6
 Lead Protective Apparel3-5
 Lead Shield.....5, 16-17
 Lobby Seating.....47

M

Magazine Rack48
 Mailers39
 Markers (26-31):
 Clippers29
 Extremity Rulers30
 Letter Holders.....31
 Letter Cases.....31
 Letters, Mounted31
 Letters, Unmounted31
 Pens30
 Personalized, Ident.....28
 Stickers30
 Timer29
 Wallboard.....27
 Words, single.....27
 Marking Pens30
 Mittens, lead.....5
 Mobile Barriers16
 Mobile Shields17
 Mobile Stand: Cass./CR.....18-19
 Monitor Mounts42, 44

O

Office Chairs46-47
 Organizers.....36, 38, 48

P

Pet Immobilizers.....10-15
 Portable Lead Shield.....17
 Positioning:
 Sandbags.....14-15
 Sponges10-13

R

Rack:
 Apron7
 Cassette36-37
 Chart Holder36
 Film Holder36

S

Safelights32
 Sandbags.....14-15
 Shields.....17
 Signs22
 Sponges.....10-13
 Stand: Instrument.....24
 Step Stool.....25
 Stools:
 Seated24, 47
 Step25
 Utility47
 Storage Boxes.....36

T

Table Top Image Holder.....18
 Tack Board.....48
 Transfer Animal Carriers20
 Thyroid Collar4

U

Utility Cart32

V

Veterinary Immobilizers10-15
 View Boxes33

W

Wall Mounted:
 Caddies38
 Film Holders36
 Workstations43

YOUR product RESOURCE LIBRARY

Connecting the Dots to make



Your Practice Better!



7117 Centennial Blvd.
Nashville, TN 37209

P: 800.251.2629 • 615.350.7030

F: 800.554.6275 • 615.350.7879

www.techno-vet.com

www.techno-aide.com

Manufacturing Excellence in Veterinary Accessories