



IMAGING ACCESSORY CATALOG



2  
0  
1  
7



# CONTENTS

---

PROTECTIVE APPAREL 2-25

---

SHIELDING / BARRIERS 26-31

---

GENERAL ACCESSORIES 32-45

---

ULTRASOUND / MRI 46-51

---

POSITIONING 52-71

---

PATIENT HANDLING 72-89

---

MARKERS 90-103

---

DARKROOM / VIEWING 104-107

---

FILING SYSTEMS 108-115

---

FUSION ERGO 116-119

INDEX ON PAGE 120-121

Copyright 2017, Techno-Aide, Inc., all rights reserved.

# FREE STUFF

on applicable garments:

- Double-Fold Binding
- Shoulder Pads
- Double Pocket
- Embroidery
- Recycling

MEDIA	BENEFITS	PROTECTION	ATTENUATION	WEIGHT
Regular Lead	Most Economical and Recyclable	100% Lead	0.5mm Pb Equiv. Protection averages 97% Attenuation over 80,100,120 KVP	9-lbs (based on medium front protection apron)
Lightweight Lead	Lighter than Regular Lead and Recyclable	Lead-Tin	0.5mm Pb Equiv. Protection averages 96.8% Attenuation over 80,100,120 KVP	8-lbs (based on medium front protection apron)
“LMG”*	Lightest Weight, Lead-Free, Environmentally Friendly	Tungsten-Antimony	0.5mm Pb Equiv. Protection averages 96.6% Attenuation over 80,100,120 KVP	7-lbs (based on medium front protection apron)

\*Media is IEC/EN 61331-1 / ASTM Approved.

**FDA REGISTERED** / Every batch of protective media is tested by an independent third-party health physics laboratory and actual attenuation figures reported.

## AH APRON-HUB Accessories

### Tools for Scanning and Labeling Protective Apparel

Stay one step ahead of the inspectors and enhance your QA! All new garments manufactured by Techno-Aide include a scannable QR Code Serial Number label for automated or manual tracking. However, we realize that you may have older, unlabeled garments or garments from another manufacturer. To update all your protective garments, we have designed this retrofit labeling kit so that your garments can be tracked utilizing the most up-to-date tracking technology available.



cat. #	description
AHSCB	2D Scanner with Cable
AHSXW	2D Scanner Wireless
AHETL	Eyelet Tool
AHES50	Silver Eyelets (50)
AHQRC	QR Code Retrofit Labels
AHDT16	Date Tags: 2016 (50)
AHDT17	Date Tags: 2017 (50)



## Protective Apparel Tracking and Inventory System!

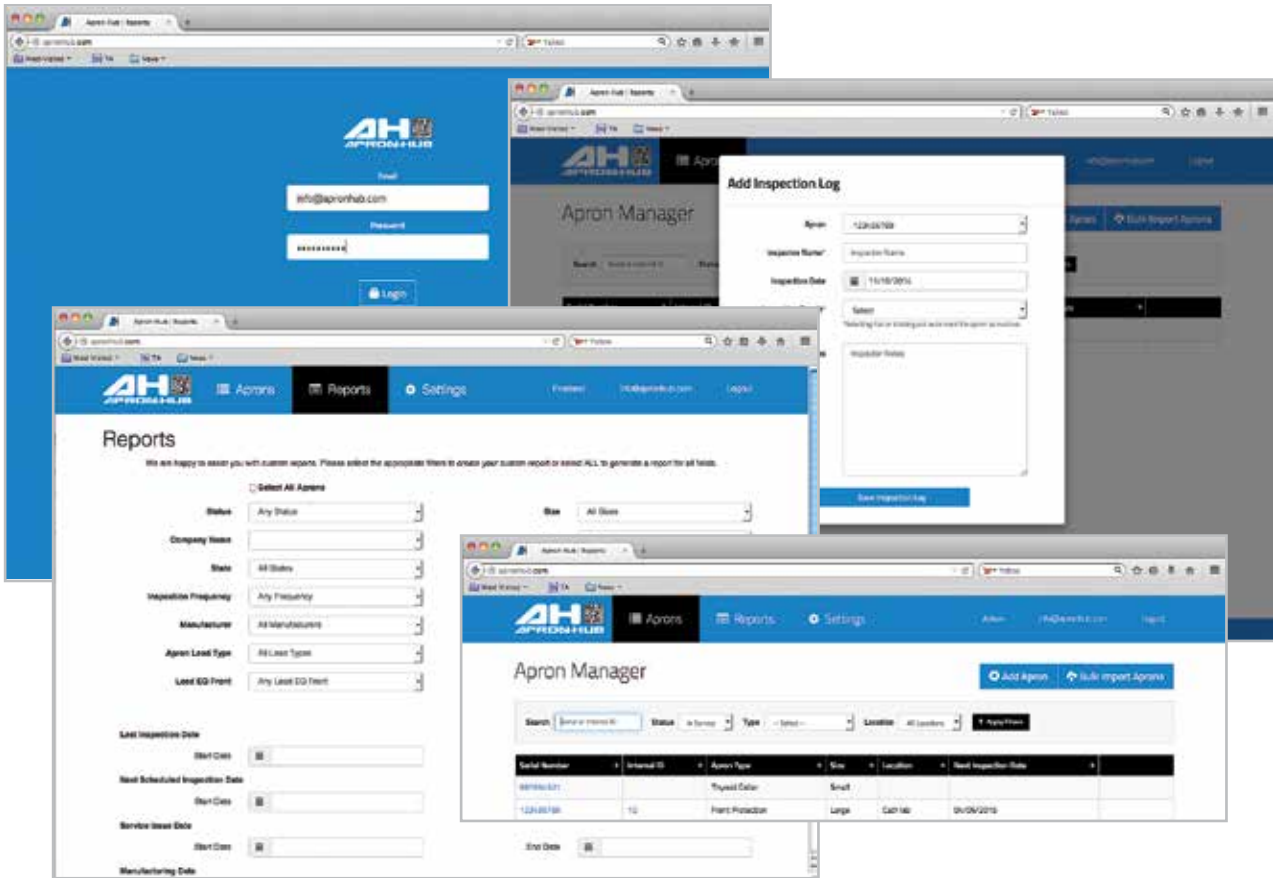

[www.apronhub.com](http://www.apronhub.com)

The exclusive online apparel tracking and inventory system from Techno-Aide.

All new Techno-Aide garments include a scannable QR code for automatic tracking. Upload garment data into your unique ApronHub portal for permanent inventory management. Receive alerts for inspection dates through a customizable format. Retrofit QR code tags onto your existing Techno-Aide or non-Techno-Aide garments. Track inspection history, location, user, etc., through a customizable reports menu. 2D Scanners are available through Techno-Aide or you can use your own 2D-scanner.

ApronHub has everything you need to quickly and easily meet the highest QA standards. For more information go to: [www.apronhub.com](http://www.apronhub.com) today!



*Most Popular Apron!*



Buckle

## EZ-Guard

### All Purpose Front Protection Apron

EZ-On / EZ-Off. Available with hook & loop or 2" buckle closure. 0.5mm Pb equivalency protection (0.375mm available). Free dual pocket and shoulder pads.

#### EZ-GUARD with Hook & Loop Closure

cat. #	lead type
EVR	Regular
EVL	Light Wt.
EVG	<a href="#">LMG Lead-Free</a>

#### EZ-GUARD with Buckle Closure

cat. #	lead type
EBR	Regular
EBL	Light Wt.
EBG	<a href="#">LMG Lead-Free</a>



Buckle

## Flex-Guard

### Flexible-Back Apron

[See Best-Fit Sizing Chart on page 22.](#)

Stretch back provides greater comfort by placing more weight on the hips and less weight on the shoulders. Available with hook & loop or 2" buckle closure. 0.5mm Pb equivalency protection (0.375mm available). Free dual pocket and shoulder pads.

#### FLEX-GUARD with Hook & Loop Closure

cat. #	lead type
FVR	Regular
FVL	Light Wt.
FVG	<a href="#">LMG Lead-Free</a>

#### FLEX-GUARD with Buckle Closure

cat. #	lead type
FBR	Regular
FBL	Light Wt.
FBG	<a href="#">LMG Lead-Free</a>

**COLORS & FABRICS:** page 25.  
Default Fabric: **Royal Blue nylon.**  
2-Year Limited Warranty.



## Surgery-Guard

Surgical Drop-Off Apron

### Easily Slides Off under Sterile Gown

No compromise of sterile field. Crossover shoulder-to-hip hook & loop closure. 0.5mm Pb equiv. front protection. Free dual pocket and shoulder pads.

cat. #	lead type
SRR	Regular
SRL	Light Wt.
SRG	<a href="#">LMG Lead-Free</a>



## OR-Guard

Shoulder Drop-Off Apron

### Slides Off under Sterile Gown

No compromise of sterile field. Flexible back, like the Flex-Guard. Break-away shoulders and hips. 0.5mm Pb equiv. front protection. Free dual pocket and shoulder pads.

cat. #	lead type
ORR	Regular
ORL	Light Wt.
ORG	<a href="#">LMG Lead-Free</a>



## Ortho-Guard

Apron with attached Belt-Guard

### Built-in Back-Guard for Maximum Support

Tethered belt can be adjusted vertically and laterally for effective back support. Back strap assures best fit and comfort. 0.5mm Pb equiv. front protection. Free dual pocket and shoulder pads.

cat. #	lead type
OGR	Regular
OGL	Light Wt.
OGG	<a href="#">LMG Lead-Free</a>

Shoulder Strap Included!

## Econo-Guard

### Economy Apron

#### Excellent Protection, Value Priced

1" buckle closure (long enough to tie). 0.5mm Pb equivalency front protection. Available in any fabric. See Best-Fit size chart on page 22.



#### ECONO-GUARD

*Not compatible with attached thyroid collar.*

cat. #	lead type
EGR	Regular
EGL	Light Wt.
EGG	LMG Lead-Free

**COLORS & FABRICS:** page 25.

Default Fabric: **Royal Blue nylon.**

2-Year Limited Warranty.

## Vest-Wrap

#### Less Bulk, Better Fit for Freedom of Movement

Separate Men and Women's styles for best comfort. Distributes weight between shoulders and hips. 0.5mm Pb equivalency protection front, 0.25mm back. Hook & loop closure with flexible back. Generous armholes for EZ-fit. Free dual pocket and shoulder pads.



#### VEST-WRAP Female

cat. #	lead type
VGR	Regular
VGL	Light Wt.
VGG	LMG Lead-Free

#### VEST-WRAP Male

cat. #	lead type
VBR	Regular
VBL	Light Wt.
VBG	LMG Lead-Free

**COLORS & FABRICS:** page 25.  
Default Fabric: **Royal Blue nylon.**  
2-Year Limited Warranty.



**Newly Tailored  
to assure the most  
Comfortable Fit!**

*See Best-Fit  
Sizing Chart  
on page 22.*

## Vest-Guard

### New Design: Saves Weight, Better Fit

Separate Men and Women's styles for best comfort. Full front overlap design saves weight. Distributes weight between shoulders and hips. 0.5mm Pb equivalency protection front, 0.25mm back. Hook & loop closure is fast and easy. Free dual pocket and shoulder pads.

#### VEST-GUARD Female

cat. #	lead type
VFR	Regular
VFL	Light Wt.
VFG	<a href="#">LMG Lead-Free</a>

#### VEST-GUARD Male

cat. #	lead type
VMR	Regular
VML	Light Wt.
VMG	<a href="#">LMG Lead-Free</a>

(Vests do not include the two 1" safety buckles as shown. If you would like these as a FREE Add-On, please specify at the time of ordering.)



## Skirt/Kilt-Guard

### All Day Comfort for the Lower Body

Separate Men and Women's styles for best comfort. Weight is distributed evenly around hips. Wrap around protection: .5mm Pb Eq front, .25mm back. Hook & loop closure with 2" safety buckle. Free pocket and waist pad.

#### SKIRT-GUARD Female

cat. #	lead type
SFR	Regular
SFL	Light Wt.
SFG	<a href="#">LMG Lead-Free</a>

#### KILT-GUARD Male

cat. #	lead type
KMR	Regular
KML	Light Wt.
KMG	<a href="#">LMG Lead-Free</a>





## Max-Wrap

Wrap around, full-body protection coat-style garment  
 Distributes weight between shoulders and hips. 0.5mm Pb equivalency protection front, 0.25mm back. Hook & loop closure with flexible back is fast and easy. Generous armholes for EZ-fit. Free dual pocket and shoulder pads.

### Innovative Max Design!

Solid front and back panels provide no overlap means less bulk, better fit, better freedom of movement, secure closure at waist and shoulder, flexible back support panels and lighter weight.

cat. #	lead type
MWL	Light Wt.
MWG	<a href="#">LMG Lead-Free</a>



## Max-Guard Plus

Overlap wrap around offers full-body protection  
 Distributes weight between shoulders and hips. 0.5mm Pb equivalency protection front, 0.25mm back. Hook & loop closure with inside elastic Back-Guard. Front belt assures snug fit and maximum support. Generous armholes for EZ-fit. Free dual pocket and shoulder pads.

cat. #	lead type
MXL	Light Wt.
MXG	<a href="#">LMG Lead-Free</a>

*Inside:  
 built-in 6"  
 elastic back  
 support.*

[See Best-Fit Sizing Chart on page 22.](#)

**COLORS & FABRICS:** page 25.  
 Default Fabric: **Royal Blue nylon.**  
 2-Year Limited Warranty.

# Thyro-Guards



## Standard

Binding all around means affordable comfort and flexibility.

cat. #	lead type
TYR	Regular
TYL	Light Wt.
TYG	LMG Lead-Free

## Attached Standard

cat. #	lead type
TAR	Regular
TAL	Light Wt.
TAG	LMG Lead-Free



## No Binding

No binding means extra comfort, flexibility and lighter weight.

cat. #	lead type
TNR	Regular
TNL	Light Wt.
TNG	LMG Lead-Free

## Attached No Binding

cat. #	lead type
TCR	Regular
TCL	Light Wt.
TCG	LMG Lead-Free



## Mid-Binding

No binding at the top means extra comfort under the chin.

cat. #	lead type
TVR	Regular
TVL	Light Wt.
TVG	LMG Lead-Free

## Attached Mid-Binding

cat. #	lead type
TWR	Regular
TWL	Light Wt.
TWG	LMG Lead-Free



(Berry with Pink ribbon only)

## Mammography

Shorty patient collar offers protection without compromising breast imaging.

cat. #	lead type
TMR	Regular
TML	Light Wt.
TMG	LMG Lead-Free



## Pediatric

Small patient collar offers protection during pediatric imaging.

cat. #	lead type
TPR	Regular
TPL	Light Wt.
TPG	LMG Lead-Free

## Attached Pediatric

cat. #	lead type
TTR	Regular
TTL	Light Wt.
TTG	LMG Lead-Free



## Buckle Closure

If you prefer buckle closure to regular hook & loop, add "-B" to any of the collar numbers above.



Unique 2-pockets in one

All Attached Thyroid Collars include: Snap ring for easy collar attachment. Attach anytime with tethered strap. Unique 2-in-1 pocket design: store collar in one pocket and use other pocket for accessories.

Standard, No-Binding, and Mid-Binding collars are 6" tall x 6½" wide x 24" strap.

Select **COLOR** and **FABRIC** on **page 25**. Default color is Royal Blue except for Mammo Collar (Berry only).



## Care-Guard

### Pregnancy Apron

#### Special Protection for Fetal Care

**Front Details:** Front protection with flexible back straps. 1.0mm Pb equivalency over fetal area, 0.5mm over remaining area. 22" x 24" pregnancy panel can be removed at completion of pregnancy to create a standard Flex-Guard Apron with 0.5mm Pb equivalency protection. Hook & loop closure is fast and easy. Free dual pocket and shoulder pads.

**Back Details:** Complements the Front Apron for full protection. 0.25mm Pb equivalency. 1" buckle closure (long enough to tie) in front.

#### CARE-GUARD Front Only

cat. #	lead type
CGL	Light Wt.
CGG	LMG Lead-Free

#### CARE-GUARD Back Only

cat. #	lead type	size	(width x length)
CBL	Light Wt.	Tall	(24" x 40")
CBG	LMG Lead-Free	Full	(28" x 38")



## Breast-Guard

### Female Breast Protection

Allows full viewing of anatomy EXCEPT sensitive breast tissue. Hook and Loop strap drapes around the neck. Adjust shields anywhere along the strap. 0.5mm Pb equiv. protection.

Two convenient sizes:

**Adult:** 6" wide x 7" high; **Child:** 4" wide x 4½" high.

Set = two shields + one strap

cat. #	lead type	size
BSR	Regular	A (Adult)
BSL	Light Wt.	C (Child)
BSG	LMG Lead-Free	



## Pregnancy Semi & Lap-Guards

### Half Apronette

Similar to Semi-Guard and Lap-Guard shown at the top of page 11, but with 1.0mm Pb equivalency protection and a 2" belt on the Lap-Guard version. Excellent protection for pregnant patients requiring x-ray.

#### 1.0mm PREGNANCY SEMI-GUARD & LAP-GUARD

SEMI cat. #	LAP cat. #	lead type
SPL	LPL	Light Wt.
SPG	LPG	LMG Lead-Free

**COLORS & FABRICS:** page 25.  
 Default Fabric: **Royal Blue nylon.**  
 2-Year Limited Warranty.

## Semi-Guard

### Extra Coverage Half Apronette

Convenient hook & loop closure. 0.5mm Pb equivalency protection. Excellent protection for patient and staff.



Individual default apronette color is Royal Blue, unless specified.

size	(width x length)
S	(12" x 12")
M	(18" x 16")
L	(24" x 20")
X	(24" x 24")
2X	(36" x 24")
Half	(24" x 12")
Kids*	(8" x 10")

\*See Kids Lap-Guard p.13

## Lap-Guard

### Buckle Closure Half Apronette

Easy-to-use 1" buckle belt closure. 0.5mm Pb equivalency protection. Excellent protection for patient and staff.



### SEMI-GUARD & LAP-GUARD

SEMI cat. #	LAP cat. #	lead type
SGR	LGR	Regular
SGL	LGL	Light Wt.
SGG	LGG	LMG Lead-Free

### SEMI-GUARD Set & LAP-GUARD Set

SEMI cat. #	LAP cat. #	lead type
STR	LTR	Regular
STL	LTL	Light Wt.
STG	LTG	LMG Lead-Free



Semi-Guard & Lap-Guard SETS include a 2-Peg Rack and the following apronettes:

small (yellow)	large (royal blue)
medium (berry)	extra-large (green)

## Demi-Guard

### Half Apron

Child to Adult loin protection. 0.5mm Pb equivalency front protection. Available with 1" buckle closure or convenient Waist Ring.



**DEMI-RACK** (only)  
Cat.# DDD

### DEMI-GUARD with Waist Rings

cat. #	lead type
DRR	Regular
DRL	Light Wt.
DRG	LMG Lead-Free

### DEMI-GUARD with Buckles or Hook & Loop

Buckle cat. #	H&L cat. #	lead type
DBR	DVR	Regular
DBL	DVL	Light Wt.
DBG	DVG	LMG Lead-Free

### DEMI-GUARD (Ring set of 4 w/ rack)

cat. #	lead type	size	(width x length)
DSR	Regular	S	(8" x 10")
DSL	Light Wt.	M	(12" x 12")
DSG	LMG Lead-Free	L	(16" x 14")
		XL	(20" x 16")

### DEMI-GUARD (Buckle or Hook & Loop Set of 4 w/ Rack)

Buckle cat. #	H&L cat. #	lead type	size	(width x length)
DGR	DYR	Regular	S	(8" x 10")
DGL	DYL	Light Wt.	M	(12" x 12")
DGG	DYG	LMG Lead-Free	L	(16" x 14")
			XL	(20" x 16")

## Gonadal-Guard

### Adult Gonadal Shields

Attached belt with 1" buckle. 0.5mm Pb equivalency protection. Available in three sizes.



#### GONADAL-GUARD (individual)

cat. #	lead type
GNR	Regular
GNL	Light Wt.
GNG	LMG Lead-Free

#### GONADAL-GUARD (set of all 3)

cat. #	lead type	size	(width x length)
GSR	Regular	S	(4" x 4.5")
GSL	Light Wt.	M	(6" x 7")
GSG	LMG Lead-Free	L	(7.5" x 9")

## Diaper-Guard

### Adult Protective Diaper

Specifically designed radiation protective diapers for adults. 0.5mm Pb equivalency protection. Convenient tie strings at each hip.

#GDR



## Gonadal-Guard

### Pediatric Gonadal Shields

Specifically designed sets will accommodate neonatal up to small children. Gender appropriate gonadal shielding. 0.5mm Pb equivalency protection.



#### MALE (Blue/set of 4)

cat. #	lead type
GMR4	Regular
GML4	Light Wt.
GMG4	LMG Lead-Free



#### FEMALE (Pink/set of 5)

cat. #	lead type
GFR5	Regular
GFL5	Light Wt.
GFG5	LMG Lead-Free

## Diaper-Guard

### Pediatric Protective Diaper

Specifically designed radiation protective diapers accommodate infants up to small children. Color-coded regular lead diapers: small (red), medium (green), large (yellow). 0.5mm Pb equivalency protection.



cat. #	back x length x front	size
GBR-S	9.5" x 11" x 5"	small
GBR-M	12.5" x 12" x 7.5"	medium
GBR-L	15.5" x 13" x 9"	large
GBS-3	set of all 3	set of 3



## Child-Guard

Front Protection for Kids

### EZ Fit, Front Protection

Front protection apron with buckle closure. 0.5mm Pb equiv. front protection. Shoulder Pads: concealed for comfort and durability. Ideal for our younger patients, creating safer and more secure protection than lead drapes or shields.

### CHILD-GUARD

cat. #	lead type
KGR	Regular
KGL	Light Wt.
KGG	LMG Lead-Free

size	(width x length)
Child	(18" x 24")



## Kids Lap/Semi-Guard

Half Apronette

Excellent protection for small patients. 0.5mm Pb equivalency protection. LAP uses 1" buckle closure and SEMI uses hook & loop.



### KIDS LAP/SEMI-GUARD

LAP cat. #	SEMI cat. #	lead type
LKR	SKR	Regular
LKL	SKL	Light Wt.
LKG	SKG	LMG Lead-Free



## Kiddie Kovers

Kid-Friendly Protection

### What makes Kiddie Kovers Unique:

Decrease anxiety and fear with a "hug" from a friendly buddy. All purpose lead blanket protects children from radiation. 0.5mm Pb equivalency protection (regular lead only). Protective panel is 18" x 18" and safe for all modalities.

cat. #	description
KK-LBUG	Ladybug
KK-BBEE	Bumble Bee
KK-TURT	Turtle
KK-BFLY	Butterfly
KK-PUPP	Puppy
KK-FROG	Frog
KK-CATT	Cat
KK-MNKY	Monkey

Ladybug



Bumble Bee

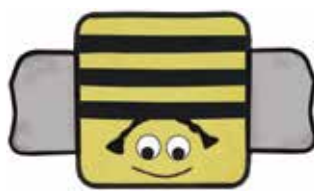

Turtle



Butterfly



Puppy



Frog



Cat



Monkey

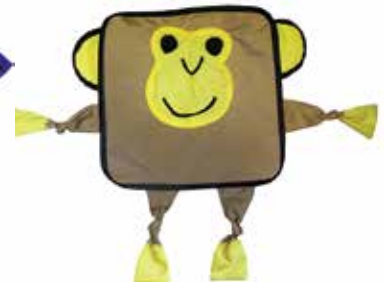

## Hand-Guard

Five fingered protection for full dexterity. Durable, soft navy vinyl covering (15"). 0.5mm Pb equiv. dip-molded core.



**HAND-GUARD** 5-Finger

cat. #	hand
HGP	Pair
HGR	Right Hand
HGL	Left Hand

## Palm-Guard

Provides hand protection with option of exposing fingers for dexterity. Durable, soft navy vinyl covering (15"). 0.5mm Pb equiv. dip-molded core.



**PALM-GUARD** Slitted Mittens

cat. #	hand
PSP	Pair
PSR	Right Hand
PSL	Left Hand

## Finger-Guard

Radiation Reducing Gloves

Finger-Guard offers sterile hand protection from secondary radiation.



#PLF offers superior tactile sensitivity with excellent attenuation.



#PFC offers excellent tactile sensitivity with good attenuation.



#PRL offers reasonable tactile sensitivity with the best attenuation.



**PLF:** Lead-Free/Powder-Free/ Latex-Free

**PFC:** Lead-Free/Latex-Free

**PRL:** Lead-Free/Powder-Free/ contains Natural Latex/beaded cuff/ textured finger tips.

cat. #	description	sizes	qty/pkg
PLF	.18mm Glove	6½, 7, 7½, 8, 8½, 9	5 Pair
PFC	.23mm Glove	6½, 7, 7½, 8, 8½, 9	5 Pair
PRL	.35mm Glove	6½, 7, 7½, 8, 8½, 9	5 Pair

### Attenuation for Finger-Guard - Broad Beam

Description	Cat.#	60 KvP	80 KvP	100 KvP	120 KvP
.18mm Glove	PLF	56.5%	47.1%	41.6%	37.7%
.23mm Glove	PFC	48.0%	40.0%	32.0%	28.0%
.35mm Glove	PRL	60.0%	53.0%	46.0%	41.0%

("mm" is actual thickness of glove in millimeters, NOT lead equivalency.)  
(Test results in accordance with ASTM Test Method F2547-06.)

## Omni-Guard

### Protective Flexible Shield

Used over a patient or equipment, protects from radiation exposure. Used underneath a patient, prevents scatter radiation. All purpose covering for patients or equipment. 0.5mm Pb equivalency protection. Choose any color fabric.



**Custom Sizes Available**

**COLORS & FABRICS:** page 25.  
Default Fabric: **Royal Blue nylon.**  
2-Year Limited Warranty.

cat. #	lead type
OMR	Regular
OML	Light Wt.
OMG	LMG Lead-Free

size	(width x length)
S	(18" x 18")
M	(24" x 24")
L	(24" x 36")
X	(24" x 48")

## Belt-Guard

### Back Support Belt

Regular #BGB  
X-Large #BGB-2



Helps reduce back stress.  
Can be used with any apron.  
6" elastic back support belt with 2" buckle closure.  
The same belt as used on the Ortho-Guard apron.

## Guard-Tote

### Apparel Tote Bag

#ACB-28



Convenient tote for all your protective wear. Durable rip-stop nylon fabric with zippered closure. 28" long to minimize folding your aprons. EZ-Carry handle and shoulder strap included.

## Hat-Guard

Specify size:  
Small - 21"  
Medium - 22"  
Large - 23 1/2"



Protection for the top of head.  
Hook & Loop fitted closure.  
0.50mm Pb equiv. sides,  
0.25mm Pb equiv. top.

### HAT-GUARD

cat. #	lead type
HCL	Light Wt.
HCG	LMG Lead-Free

## Hood-Guard

One Size Fits All.



Long procedure protection.  
Covers the entire head.  
Hook & Loop closure.  
0.5mm Pb equivalency.

### HOOD-GUARD

cat. #	lead type
HOL	Light Wt.
HOG	LMG Lead-Free





Model#	Color
LER-9SPL	Silver
LER-9KPL	Black
LER-9TPL	Taupe

Plano Lens  
(Prescription Lens available)



## Ultra-Guard

**Ultra-light and super stylish.**

Curved lens adds to lateral protection. Regular hinges with wrap around frame. Universal bridge support. Available in most prescriptions. Includes premium case.

Lead Equiv.: 0.75mm lens.

Weight: 60 grams.

Frame: impact resistant polycarbonate.



Model#	Color
LER-ACPL	Carbon/Gray
LER-APPL	Purple/Gray
LER-AYPL	Yellow/Blue

Plano Lens  
(Prescription Lens available)



## Avant-Guard

**Two-tone colorful Ultra-Guards.**

Curved lens adds to lateral protection. Regular hinges with wrap around frame. Universal bridge support. Available in most prescriptions. Includes premium case.

Lead Equiv.: 0.75mm lens.

Weight: 60 grams.

Frame: impact resistant polycarbonate.



Model#	Color
LER-CBPL	Blue
LER-CRPL	Red
LER-CGPL	Green
LER-CPPL	Purple
LER-CKPL	Black
LER-COPL	Orange

Plano Lens  
(Prescription NOT available)



## Color-Guard

**Bright-tone colorful Ultra-Guards.**

Curved lens adds to lateral protection. Regular hinges with wrap around frame. Universal bridge support. Available in most prescriptions. Includes premium case.

Lead Equiv.: 0.75mm lens.

Weight: 60 grams.

Frame: impact resistant polycarbonate.

# PROTECTIVE APPAREL

radiation protection for your eyes



Model#	Color
LER-DSPL	Silver
LER-DKPL	Black

Plano Lens  
(Prescription Lens NOT available)

## Predator-Guard

**Radiation protection and splash protection.** Close fit provide excellent visibility. Extra soft nose pads for superior comfort. Wrapping lens area increases protection. For larger framed faces. Includes premium case.

Lead Equiv.: 0.75mm lens.  
Weight: 70 grams.  
Frame: impact resistant polycarbonate.



Model#	Color
LER-TRPL	Red
LER-TKPL	Black
LER-TSPL	Silver

Plano Lens  
(Prescription Lens available)



## Turbo-Guard

**For that sharp and stream-lined look.** Large lens area for excellent coverage. Rubberized temple bars for comfortable grip. Rubber, ultra-soft, fixed nose pad. Available in almost all prescriptions. Includes premium case.

Lead Equiv.: 0.75mm lens.  
Weight: 65 grams.  
Frame: impact resistant nylon.



Model#	Color
LER-6SPL	Silver
LER-6KPL	Black
LER-6RPL	Red
LER-6BPL	Blue

Plano Lens  
(Prescription Lens available)



## Sure-Guard

**Stylish design for medium faces.** Large lens area for excellent coverage. Regular hinges with wrap around frame. Rubber, ultra-soft, fixed nose piece. Available in almost all prescriptions. Includes premium case.

Lead Equiv.: 0.75mm lens.  
Weight: 63 grams.  
Frame: impact resistant plastic.



Model#      Color  
 LES-53PLT      Tortoise  
 LES-53PLC      Crimson  
 LES-53PLB      Blue  
 Plano Lens  
 (Prescription Lens available)



## Wrap-Around

The “original” with great side protection. Generous lens area increases protection. Spring hinges and adjustable nose. Available in most prescriptions. Includes premium case.

Lead Equiv.: 0.75mm lens.  
 Frame: impact resistant plastic.



Model#      Color  
 LER-VFPL      Fancy Flight  
 LER-VVPL      Cherry Vines  
 LER-VSPL      Rad Skull  
 Plano Lens  
 (Prescription Lens available)



## Viva-Guard

Lively designs for small to medium faces. Smaller frame for excellent fit of smaller faces. Regular hinges with wrap around frame. Ultra soft bridge support. Available in most prescriptions. Includes premium case.

Lead Equiv.: 0.75mm lens.  
 Weight: 60 grams.  
 Frame: impact resistant polycarbonate.



Model#      Color  
 LER-PBPL      Blue/Orange  
 LER-PSPL      Silver/Pink  
 LER-PKPL      Black/Gray  
 Plano Lens  
 (Prescription Lens available)



## Power-Guard

Colortone accents increase comfort. Large lens area for excellent coverage. Soft colored endpiece for comfort and fit. Padded bridge, temples, and endpiece. Available in most prescriptions. Includes premium case.

Lead Equiv.: 0.75mm lens.  
 Weight: 64 grams.  
 Frame: impact resistant polycarbonate.

# PROTECTIVE APPAREL

radiation protection for your eyes



Model# Color  
LES-AFYK Black/Yellow  
LES-AFPW Purple/White  
LES-AFGP Gray/Pink

Plano Lens  
(Prescription Lens available)



## Astro-Guard

### Side Shield protection.

Attractive and sturdy women's frames. Flexible temples fit almost any face. Excellent visibility. Available in most prescriptions. Includes premium case.

Lead Equiv.: 0.75mm lens.

Weight: 66 grams.

Frame: impact resistant plastic.



Model# Color  
LES-CKPL Black  
LES-CWPL White  
LES-CTPL Tortoise

Plano Lens



## Cover-Guard

### Comfortable protection over regular glasses.

Excellent front and side visibility. Provides limited splash protection. Can be worn over prescription eyewear. Regular hinges with molded nose piece. Includes 0.75mm Pb glass side shields. Includes premium case.

Lead Equiv.: 0.75mm front and sides.

Weight: 85 grams.

Frame: black rubberized nylon.



Model# Color  
LES-RKPL Black

Plano Lens  
(Prescription Lens available)

## Secure-Guard

### Vented goggle for extreme protection.

Adjustable headband keeps goggles securely on head and prevents slippage. Neoprene foam cushioning for facial comfort. Large lens pocket allows for maximum viewing area. Vented to prevent fogging.

Lead Equiv.: 0.75mm lens.

Weight: 66 grams.

Frame: impact resistant plastic.

## Mobile Apron Rack

Ten (10) swing-arm mobile garment stand. Durable all-steel construction. 24" x 24" H-Base for stability and easy cleaning. E-Z-Roll swivel locking casters. Convenient handle for easy mobility. Neutral Almond baked enamel finish. Overall height is 55". Some assembly required. Ships @ 110 lb.



Standard Mobile Rack  
#ARM-100

Standard WITH Glove Rack  
#ARM-G60



Aprons not included.

Easy-Clean  
H-Base!



Arms swing inward to conserve space.

## Mobile Apron Z-Rack

Z-Base mobile rack nests with others when not in use. Heavy duty casters on 12G steel base. Chromed-steel posts and hang bar. 60"long x 60"tall bar allows hanging without creasing. Ships @ 35 lbs.

Rack ONLY  
#ARM-ZNH

Rack with  
Ten Hangers  
#ARM-Z10



## Apron Hangers

Designed for standard aprons, panoramic, vests, skirts, etc. Top hook swivels for easy hanging. 21" long chromed-steel with anti-slip tips. Glove holders mounted onto back panel. Use on ARM-ZNH rack, peg rack, etc. Single ships @ 2 lbs.

Single Hanger  
#ARH-01

Set of 10  
#ARH-10



## Wall Mounted Apron Racks

Ten or five swing-arm wall-mount apron racks. Mounting holes on 16" centers. All-steel durability with almond enamel finish. 10-Arm Ships @ 25 lb. / 5-Arm Ships @ 17 lb.



10-ARM #ARW-10



5-ARM, SWING LEFT #ARW-L5



5-ARM, SWING RIGHT #ARW-R5



## Glove Adapter

Retrofits to Mobile Rack. Holds six (6) 18" gloves. Ships @ 8 lb.



#ARG-06

## Apron Peg Racks

6" angled pegs keep garments from slipping. All-steel Almond enamel finish.



2-peg  
(for 1 apron)

#ARP-02  
Ships @ 4 lb



6-peg  
(for 3 aprons)

#ARP-06  
Ships @ 10 lb



6-peg and 8-peg racks: mounting holes on 16" and 24" centers.

8-peg  
(for 4 aprons)

#ARP-08  
Ships @ 11 lb



## Apron/Glove Racks

Designed for one apron, but will hold more. All steel, heavy duty construction. 16" & 24" holes match most wall studs. Glove holders mounted onto back panel. 28.5" long x 1.75" diameter bar prevents creasing. Ships @ 13 lbs.



Without  
Glove Holders  
#AGR-105



With Two  
Glove Holders  
#AGR-110



Aprons not included.

# Best-Fit Sizing Charts

## Front Protection Apron

size	front width	length	chest circumference
Petite	20"	32"	< 36"
Small	21"	34"	< 40"
Medium	22"	36"	< 44"
Large	24"	38"	< 48"
X-Large	26"	40"	< 52"
2X	28"	40"	< 56"
3X	30"	40"	< 60"

## Vest (male) & Full Wrap Around

size	chest/tummy	vest length	full wrap length
Petite	35"-36"	19.5"	32"
Small	37"-38"	20"	34"
Medium	39"-41"	21"	36"
Large	42"-44"	22"	38"
X-Large	45"-49"	23"	40"
2X	50"-54"	24"	40"
3X	55"-59"	24"	40"

Sizes shown for apparel other than Front Protection are actual body measurements.

All lengths are from the sternal notch or waist downward, depending on the garment.

## Vest (female)

size	bust	waist	hip	length
Petite	33"-34"	< 31"	35"-36"	19"
Small	35"-36"	< 33"	37"-38"	19.5"
Medium	37"-38"	< 35"	39"-40"	20"
Large	39"-41"	< 39"	41"-43"	21"
X-Large	42"-44"	< 41"	44"-46"	22"
2X	45"-49"	< 46"	47"-51"	23"
3X	50"-54"	< 51"	52"-56"	23"

## Skirt / Kilt

size	waist	hip	length
Petite	25"-27"	32"-34"	19"
Small	28"-29"	35"-36"	19"
Medium	30"-33"	37"-40"	20"
Large	34"-37"	41"-44"	21"
X-Large	38"-41"	45"-48"	22"
2X	42"-45"	49"-52"	22"
3X	46"-50"	53"-57"	22"

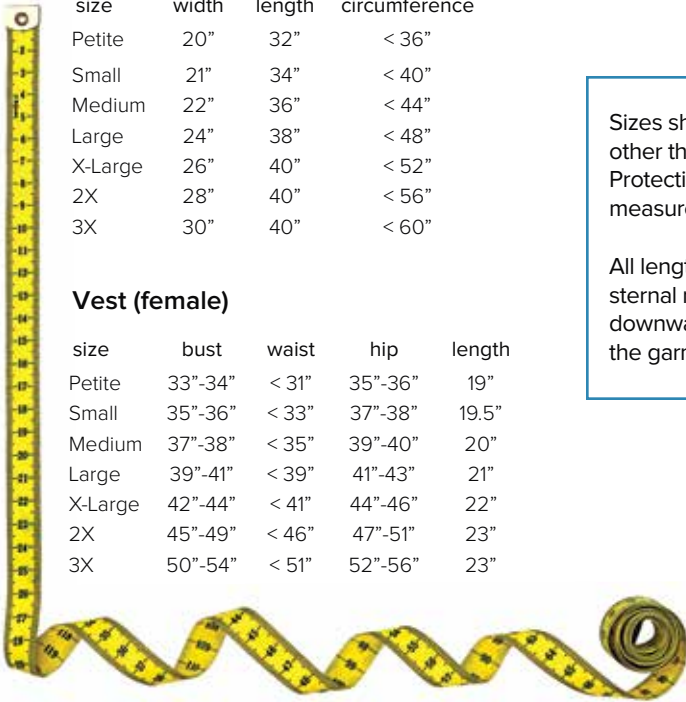

## Matching the Apron to You

Techno-Aide Sizing Charts are based on averages. But let's face it... nobody is average! So, in order to get the Best Fit for You, please consider the following when measuring yourself for either a Standard or a Custom garment:

- **PROTECTION IS PRIMARY:** Why are you wearing an apron? Protection from radiation! Some companies promise lighter weight garments, but their garments just don't measure up to proper specs. At Techno-Aide, we're much more concerned about your health and safety. Comfort is important, and while our garments are comfortable, comfort will always take a back seat to protection. Isn't that why you're purchasing Protective Apparel?
- **CIRCUMFERENCE CONSIDERATIONS:** when measuring for a Front Protection Apron, measure from one side of the widest part of your body, around to the other side - the actual distance you want protected. Then, tell us if that measurement is your chest, tummy, or hips.
- **HEIGHT CONSIDERATIONS:** in relation to your circumference, do you have a long or short torso? We want to make sure that you are adequately protected!

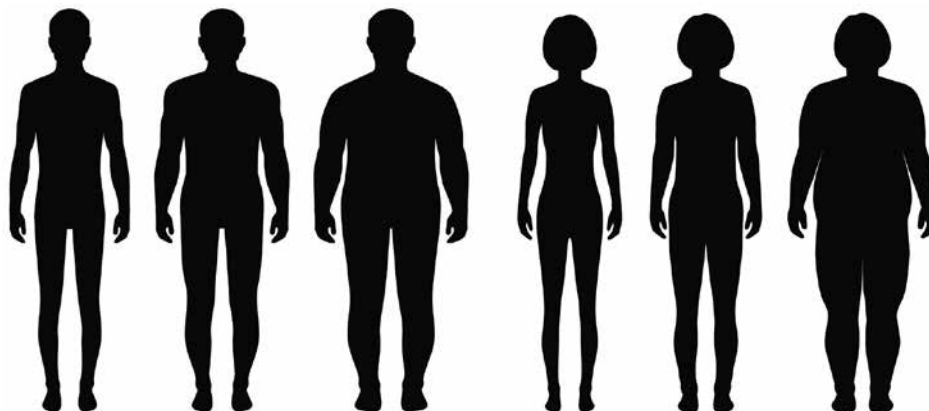

## Getting the Best-Fit

If you don't think that our standard sized garments will fit you properly, we are pleased to offer you the chance to create your own size, to fit your specific body measurements. Just complete the form below and we will create your customized protective wear. Please note, that due to the nature of customized apparel, these garments cannot be returned. Please be accurate. Thanks!

NAME \_\_\_\_\_ FACILITY \_\_\_\_\_

ADDRESS 1 \_\_\_\_\_ ADDRESS 2 \_\_\_\_\_

CITY \_\_\_\_\_ STATE \_\_\_\_\_ ZIP \_\_\_\_\_

DAYTIME PHONE \_\_\_\_\_ EMAIL \_\_\_\_\_

APRON CAT.# \_\_\_\_\_ DESCRIPTION \_\_\_\_\_ LEAD TYPE \_\_\_\_\_

FABRIC (p25) \_\_\_\_\_ BINDING COLOR (p24) \_\_\_\_\_

EMBROIDERY (OPTIONAL) LINE 1, UP TO 24-LETTERS (FREE) \_\_\_\_\_

EMBROIDERY LINE 2, UP TO 24-LETTERS (\$10.00) \_\_\_\_\_

EMBROIDERY THREAD COLOR (p24) \_\_\_\_\_ LETTER STYLE (p24) \_\_\_\_\_

ADD ATTACHED THYROID COLLAR? YES NO CAT.# \_\_\_\_\_ (COLOR WILL MATCH APRON)

## Getting Accurate Measurements (all in inches)

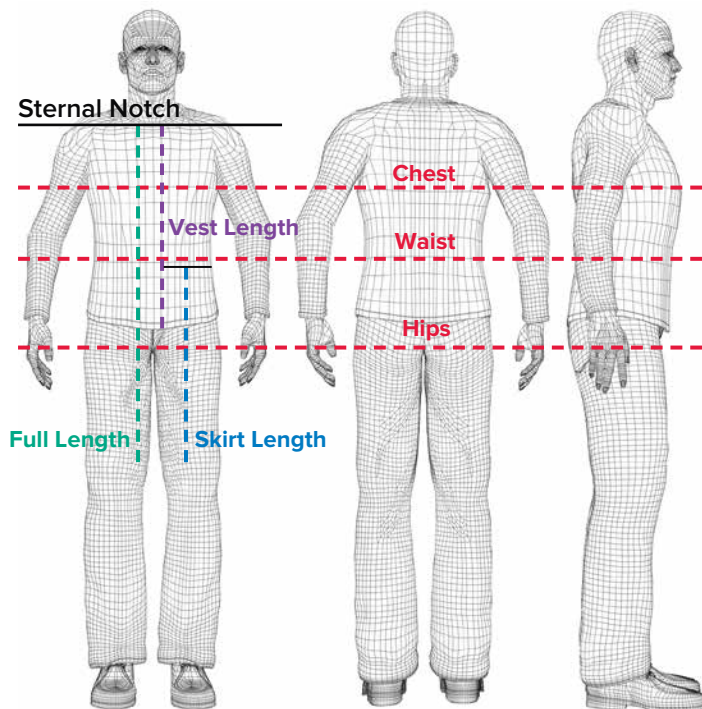

BUST/CHEST: \_\_\_\_\_  
Circumference around the widest part of your chest.

SIDE-to-SIDE: \_\_\_\_\_  
The widest part of your body that you want covered by a Front Protection Apron. Please specify the this area (circle): chest / tummy / hips

WAIST: \_\_\_\_\_  
Standard Apron: measure your waistline.  
Skirt/Kilt: measure where you want the skirt/kilt top (may be higher than your regular waistline).

HIP: \_\_\_\_\_  
Circumference around the widest part of your hips.

LENGTH:  
FRONT APRON or WRAP-AROUND: \_\_\_\_\_  
Sternal notch to just above the knee.

VEST/TORSO: \_\_\_\_\_  
Sternal Notch to desired length below your waist.

SKIRT/KILT: \_\_\_\_\_  
Desired skirt/kilt top (may be above your regular waistline) to just above your knee.

*Please photocopy this page to submit your order.*



## Embroidery Sewn-In

Selected garments come with first line FREE embroidery! Add flexibility with an embroidered patch. Please specify what you want embroidered and which type style you prefer (see below). Embroidered items are non-returnable, non-refundable.

First Line up to 24-Letters: \$FREE!

Select a Style:

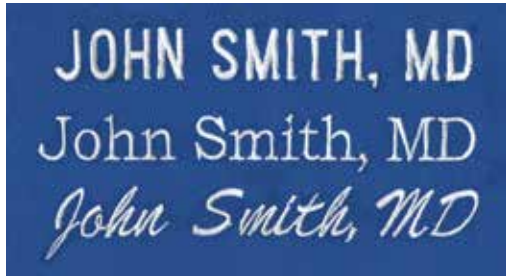

ALL CAPS (default)

Block

Script

Additional lines up to 24-letters: Call for price

## Embroidery Add-On Patch

This flexible option has your information embroidered onto a patch. Hook & Loop on the back of the patch and on the garment secure the patch in place.

#EMP (Patch)



(Patch above pocket)



## Shoulder Strap (FREE Option!)



#EMS  
\$-No Charge!

Simply ask for it with your order. Hook & loop Strap is attached to one shoulder and reaches across to the other. Helps keep shoulders high and comfortable.

## Accent Colors

Optional BINDING Colors:

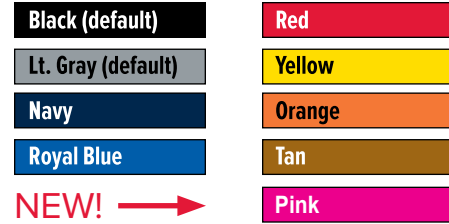

(The black or gray stripe on each fabric square is the default binding color for that fabric.)

Optional EMBROIDERY Colors:



## Things to Remember

CARE AND MAINTENANCE:

Always hang your garment on large diameter hangers. Do not wad or fold your garment, as that may weaken the level of protection on the folded seam. Do not store sharp objects in the pockets or store the garment on top of a sharp object.

WARRANTY:

Two-Year Warranty on materials and workmanship.



## Recycle

Techno-Aide will gladly accept your old, leaded Techno-Aide Brand aprons for recycling. Call for a "Recycle Return Authorization." There will be no charge to you; we only ask that you pay for your own shipping. "Lead-Free" apparel is environmentally friendly and does not need to be recycled.

# PROTECTIVE APPAREL

fabric / color selections

## Nylon Solids

Liquid Repellent  
Light & Supple



11-Royal Blue



12-Navy



20-Green



21-Teal



22-Forest



23-Slate



33-Black



41-Sunshine



43-Orange



51-Red



52-Hot Pink



53-Purple



54-Berry



55-Burgundy



56-Brown

## Colorful Prints

Liquid Repellent  
Medium Weight



70-Blue Plaid



71-Leopard



72-Lots-O-Dots



73-Sleepy Sheep



77-Life Vines



78-Waterfall



83-Cool Waves



82-Pink Camo



86-Camo Night



85-Digital Camo



94-Big Dipper



95-Andromeda



74-Playful Pups



76-Blue Paws



80-Red Paws

(Prints are shown SMALLER than actual size)

## Diamond Ripstop

Medium Weight Nylon  
Filament Reinforced



61-Sapphire



62-Ruby



63-Emerald



64-Onyx



65-Amethyst

## Feather Ripstop

Light Weight Nylon  
Filament Reinforced



R701-Royal Blue



R702-Red



R703-Forest



R704-Black



R705-Chocolate

TEN NEW  
RIPSTOPS!



R706-Navy



R707-Burgundy



R708-Kelly



R709-Charcoal



R710-Gray

## Natura

Smooth, Soft, Flexible  
with a Natural Feel



N911-Stratos



N921-Ocean



N933-Midnight

- "White" and "Black" denote the default embroidery color.
- The Black and Gray lines denote the default binding trim color.

NEW STYLE  
FABRIC!

## TECHNO-SHIELD: REAL STOPPING POWER!



### Viewing Window Barriers

Bring a full **2.0mm Pb Equivalency** of radiation protection anywhere you need it with our x-ray protective mobile barriers.

Each Barrier features:

**10" w x 12" h** clear window made of x-ray protective leaded glass; Window center is 60" from the bottom of the panel. Opaque barrier section is made of solid, leaded x-ray protection; Locking caster system for easy mobility (it is recommended that two people move the barrier for safety); Crated for secure shipment. **NOTE:** 84" barriers may not fit through some doorways.



#PBMW-2472  
(Call for Price)  
Leaded Glass: 10" w x 12" h  
Overall Size: 24" w x 72" h  
Ships @ 350 lbs.



#PBMW-3072  
(Call for Price)  
Leaded Glass: 10" w x 12" h  
Overall Size: 30" w x 72" h  
Ships @ 450 lbs.

### Procedure Barrier with arm cut-outs



#PBMB-7830  
(Call for Price)  
Leaded Glass: 30" w x 22" h  
Overall Size: 34" w x 78" h  
Cut-out width: 22.5"  
Ships @ 425 lbs.



#PBMW-3672  
(Call for Price)  
Leaded Glass: 10" w x 12" h  
Overall Size: 36" w x 72" h  
Ships @ 450 lbs.



#PBMW-2484  
(Call for Price)  
Leaded Glass: 10" w x 12" h  
Overall Size: 24" w x 84" h  
Ships @ 450 lbs.



#PBMW-3084  
(Call for Price)  
Leaded Glass: 10" w x 12" h  
Overall Size: 30" w x 84" h  
Ships @ 450 lbs.

## TECHNO-SHIELD MOBILE BARRIERS

### Viewing Panel Barriers

Bring a full **2.0mm Pb Equivalency** of radiation protection anywhere you need it with our x-ray protective mobile barriers.

Each Barrier features:  
 Transparent/clear upper section of x-ray protective leaded glass; Opaque lower section of solid, leaded x-ray protection; Locking caster system for easy mobility (it is recommended that two people move the barrier for safety); Crated for secure shipment.



#PBMB-3024  
 (Call for Price)  
 Leaded Glass: 30”w x 24”h  
 Opaque Panel:30”w x 48”h  
 Overall Size: 33”w x 75”h  
 Ships @ 450 lbs.



#PBMB-3060  
 (Call for Price)  
 Leaded Glass: 30”w x 60”h  
 Opaque Panel:30”w x 12”h  
 Overall Size: 33”w x 75”h  
 Ships @ 450 lbs.



#PBMB-4830  
 (Call for Price)  
 Leaded Glass: 48”w x 30”h  
 Opaque Panel:48”w x 42”h  
 Overall Size: 51”w x 75”h  
 Ships @ 450 lbs.



#PBMB-4836  
 (Call for Price)  
 Leaded Glass: 48”w x 36”h  
 Opaque Panel:48”w x 36”h  
 Overall Size: 51”w x 75”h  
 Ships @ 650 lbs.



#PBMB-7236  
 (Call for Price)  
 Leaded Glass: 72”w x 36”h  
 Opaque Panel:72”w x 36”h  
 Overall Size: 75”w x 75”h  
 Ships @ 700 lbs.

A mobile barrier should offer greater protection than an apron. Techno-Shield provides **2.0mm Pb Equivalency** protection!

*Leaded Glass panels by Schott, the world leader in protection and quality.*

## Standard Shield

0.5mm Pb equivalency.

Adjustable height: 36" to 60". Stable, five-legged star base. Default color: royal blue.



### 0.5mm - SHIELDING

cat. #	media	width x height
LPS-S2424	lead	24" x 24"
LPS-S2436	lead	24" x 36"
LPS-S2448	lead	24" x 48"
LPSG-S2424	lead-free	24" x 24"
LPSG-S2436	lead-free	24" x 36"
LPSG-S2448	lead-free	24" x 48"

*See Fabric Selection for all Shields on page 25.*

## Max-Shield

0.5mm Pb equivalency.

Adjustable height: 8" to 60". All steel H-base for maximum stability. Hardened chrome steel post. Posi-Lock height adjustable arm with spring-loaded pin. Default color: royal blue.

### 0.5mm - SHIELDING

cat. #	media	width x height
LPS-H3636	lead	36" x 36"
LPS-H4848	lead	48" x 48"
LPSG-H3636	lead-free	36" x 36"
LPSG-H4848	lead-free	48" x 48"

### 1.0mm - SHIELDING

cat. #	media	width x height
LPS-H3636-1	lead	36" x 36"
LPS-H4848-1	lead	48" x 48"
LPSG-H3636-1	lead-free	36" x 36"
LPSG-H4848-1	lead-free	48" x 48"

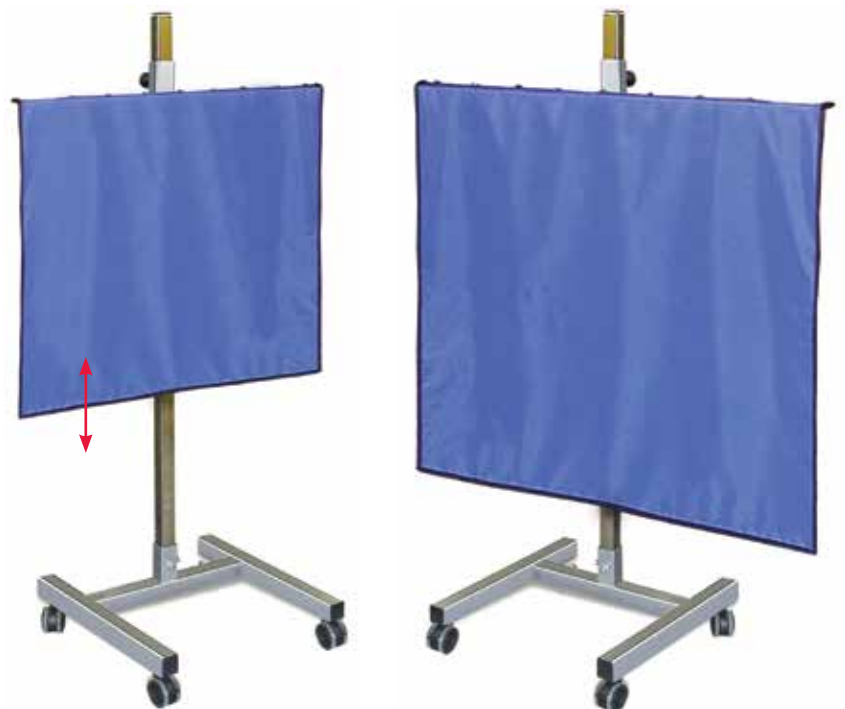

## Solid Panel Deluxe Shield

0.5mm Pb equivalency. Adjustable height: 8" to 60". Steady all steel T-base. Hardened chrome steel post. Posi-Lock height adjustable arm with spring-loaded pin. Default color: royal blue. Also available in 1.0mm lead and lead-free in both thicknesses.

### 0.5mm - REGULAR LEAD

cat. #	w x h
LPS-T2424S	24" x 24"
LPS-T2430S	24" x 30"
LPS-T2436S	24" x 36"
LPS-T2442S	24" x 42"
LPS-T2448S	24" x 48"
LPS-T3024S	30" x 24"
LPS-T3030S	30" x 30"
LPS-T3036S	30" x 36"
LPS-T3042S	30" x 42"
LPS-T3048S	30" x 48"



## Pleated Panel Deluxe Shield

0.5mm Pb equivalency. 24" has four panels, 30" has five. Adjustable height: 8" to 60". Steady all steel T-base. Hardened chrome steel post. Posi-Lock height adjustable arm with spring-loaded pin. Default color: royal blue. Also available in 1.0mm lead and lead-free in both thicknesses.

### 0.5mm - REGULAR LEAD

cat. #	w x h
LPS-T2424P	24" x 24"
LPS-T2430P	24" x 30"
LPS-T2436P	24" x 36"
LPS-T2442P	24" x 42"
LPS-T2448P	24" x 48"
LPS-T3024P	30" x 24"
LPS-T3030P	30" x 30"
LPS-T3036P	30" x 36"
LPS-T3042P	30" x 42"
LPS-T3048P	30" x 48"



## Standing Shield

Bring 0.5mm Pb equivalency of radiation protection anywhere you need it.

The 48" tall x 21½" wide x 16" deep unit comes fully assembled on a sturdy H-Base frame of powder coated steel. Grip handle on the back of the unit facilitates easy mobility. Default color: royal blue.

Cat.# LPS-HT-2448



## Table Drape Shielding

Protect staff from scatter radiation without obstructing the C-Arm. 0.5mm Pb equivalency. Attaches with hook & loop (all included). Order two for double-sided use. Available in three widths: 24", 36" and 48". Mix sizes to fill desired width of coverage. Available in three heights: 24", 30" and 36". Default color: royal blue.



### Main Drape

cat. #	panel count	width x height
TDP-2424	4-panels	24" x 24"
TDP-2430	4-panels	24" x 30"
TDP-2436	4-panels	24" x 36"
TDP-2442	4-panels	24" x 42"
TDP-3024	5-panels	30" x 24"
TDP-3030	5-panels	30" x 30"
TDP-3036	5-panels	30" x 36"
TDP-3042	5-panels	30" x 42"
TDP-3624	6-panels	36" x 24"
TDP-3630	6-panels	36" x 30"
TDP-3636	6-panels	36" x 36"
TDP-3642	6-panels	36" x 42"
TDP-4824	8-panels	48" x 24"
TDP-4830	8-panels	48" x 30"
TDP-4836	8-panels	48" x 36"
TDP-4842	8-panels	48" x 42"
TDP-CUST	Custom	Choose

### Anesthesia Drape

cat. #	panel count	width x height
TDP-2024	3-panels	20" x 24"
TDP-2030	3-panels	20" x 30"
TDP-2036	3-panels	20" x 36"
TDP-2042	3-panels	20" x 42"
TDP-2224	4-panels	22" x 24"
TDP-2230	4-panels	22" x 30"
TDP-2236	4-panels	22" x 36"
TDP-2242	4-panels	22" x 42"
TDP-CUST	Custom	Choose

## CR Cart Drapes

Protect receptor plates from scatter radiation. Specifically designed for the Agfa CR-30X cart or models of equal design and size. Provides 0.5mm Pb Equivalency shielding. Complete kit includes the four panels shown below, plus three 36" self-adhesive "loop" strips with which to easily attach the panels to the cart. Choose from dozens of fabric design and color options.



**Complete 4-Panel Kit**  
#TDP-C30

*Protection  
from Scatter  
Radiation!*



**Left Side Panel**  
(#TDP-3628)

6-flaps @ 36" w x 28" h



**Front Panel**  
(#TDP-3628)

6-flaps @ 36" w x 28" h



**Right Side Panels**  
(#TDP-2728)

4-flaps @ 27" w x 28" h  
(#TDP-0528)  
1-flap @ 5" w x 28" h

## Lead Blockers

Maximize efficiency and optimize use of receptors.  
 Divides receptor for multiple exposures. Covered with blue vinyl laminate. Flexible vinyl-lead positions easily.  
 Cleans easily with most common disinfectants. Provides 1.0mm Pb Equivalency shielding.



cat. #	blocker size	fits receptor
FLB-58	5" x 8" (13x18cm)	8" x 10"
FLB-52	5" x 12" (13x30cm)	10" x 12"
FLB-61	6" x 10" (15x24cm)	10" x 12"
FLB-71	7" x 11" (18x28cm)	11" x 14"
FLB-77	7" x 17" (18x43cm)	14" x 17"
FLS-78	set of all FIVE	Save 10%



## Lead-Lined Wall Bin

Protect your investment when plates are not in use.  
 Solid steel construction with vinyl-lead lining. Provides 1.0mm Pb Equivalency shielding. Specifically designed for receptor plates. Opening is 22" w x 5" d x 14" h.



Lead-Lined with shielded body.

#80LL

Wall Bin overall size:  
 22" w x 5<sup>3</sup>/<sub>8</sub>" d x 22" h  
 Shipping weight: 25 lbs.

## Lead-Lined Table-Top Bin

Store multiple receptors without worry of scatter radiation. 14-gauge welded steel construction with vinyl-lead lining. Provides 1.0mm Pb Equivalency shielding from scatter. Bumper guards protect receptors from impact damage. Opening is 16" w x 19" d x 20" h.



Lead-Lined with shielded body.

#CPH-LL12

Unit above with shielded door:  
 #CPH-LD12



## Mobile CR/DR/Film Image Receptor Holders

**ALL MOBILE UNITS INCLUDE:**

Vertical range from bottom of image receptor: floor-to-54". Posi-Lock height adjustable arm with spring-loaded pin. Features 60" chromed steel post. 24" H-Base with locking casters. Broad base prevents tipping. Platinum baked enamel finish. 1½" deep channels accept grids and caps. Units ship in two cartons: 1@15#, 1@45#.

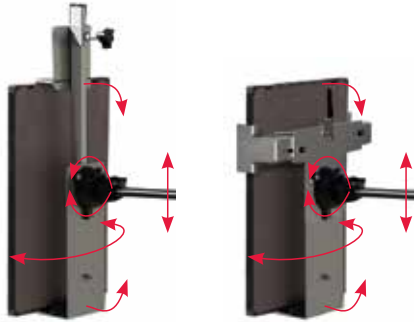

**SERIES-B**      **SERIES-C**  
Tilt & Rotate Models  
MCH-33 & MCH-37

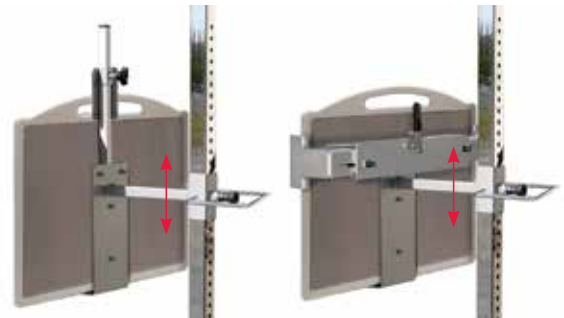

**SERIES-B**      **SERIES-C**  
Non-Tilt, Non-Rotate Model  
MCH-40

**Tilt & Rotate  
Range of Motion:**

- Straight Vertical
- Incline Forward
- Incline Backward
- Rotate or Oblique Tilt
- Face Up
- Face Down
- Anywhere in Between

**Ordering Guide:**

- **SERIES-B (Vertical Clamp)**
  - height limit up to 20"
  - no width limit
- **SERIES-C (Bilateral Clamps)**
  - no height limit
  - width limit 13½" to 20½"
- **WEIGHT LIMITS:**
  - MCH-33/MCH-37 up to 12-lbs.
  - MCH-40 up to 22-lbs.

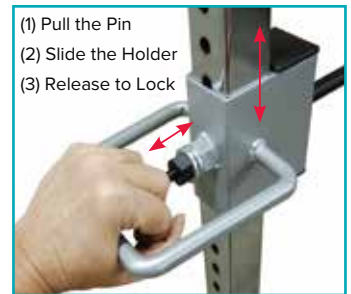

All models feature the safe and secure Posi-Lock Handle

## Tabletop Lateral Cassette/CR-DR Receptor Holders

Accepts grids and caps (channel is 1¼"d). Upper and lower channels slide on 24" post. Holds receptors up to 24" inches tall. Base plate slides under patient or pad. 35LCH upper channel includes a R & L marker. 40LDH features an upper channel that fits into handle and an extra large base for stability. Upper and lower channels are lined with no-skid vinyl. Shipping weight: 35LCH @ 7 lbs / 40LDH @ 9 lbs.

24" Variable Height  
CR-Plate/Cassette Holder  
#35LCH



24" Variable Height  
DR-Plate Holder  
#40LDH

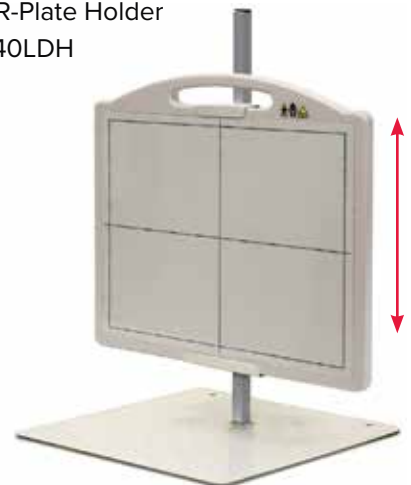

## Mobile Tilt & Rotate Image Receptor Holders

Standard arm length provides maximum stability.  
Fully articulating holder for Film / CR / Light DR receptors.  
Weight limit for both Series-B and Series-C is 12-lbs.  
See additional specs on page 32.

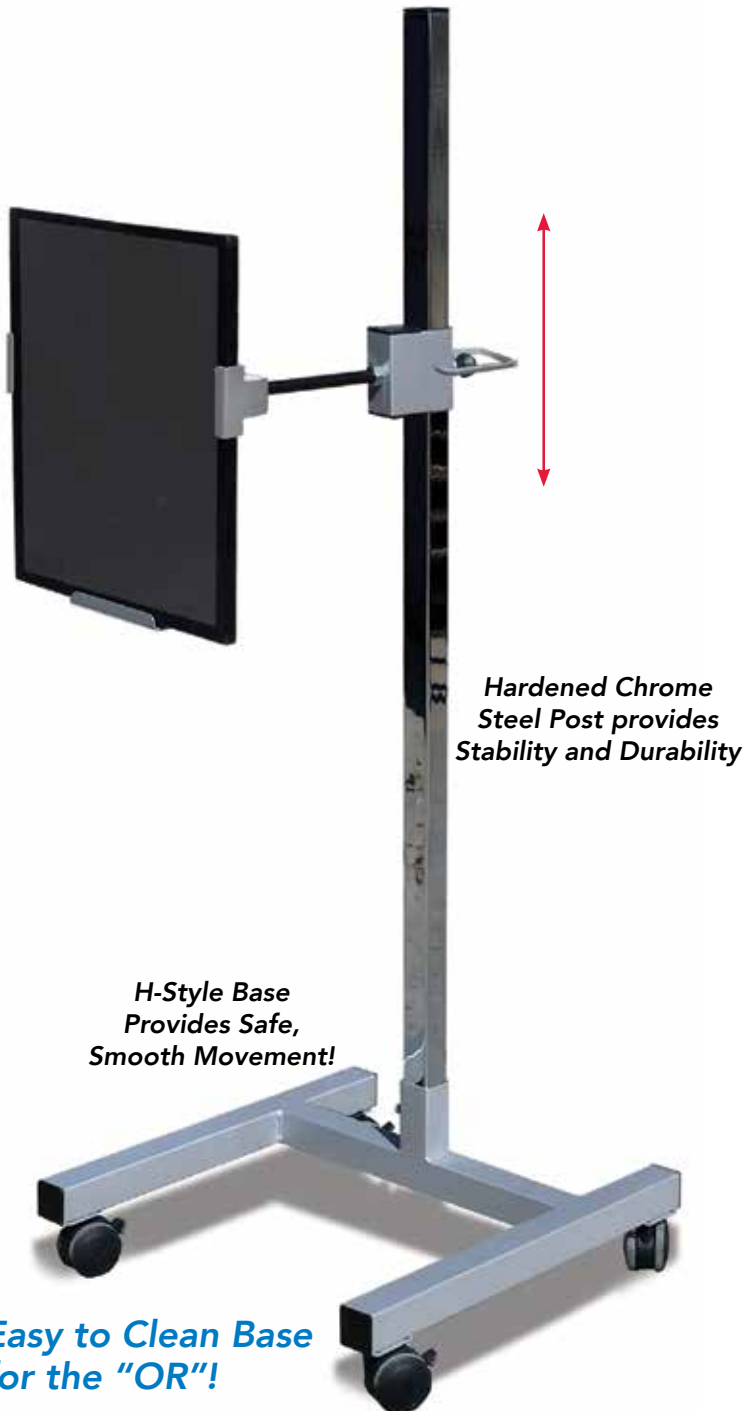

## Mobile Non-Tilt, Non-Rotate Holder for Heavy Receptors

Features a fixed position holder (non-articulating) for stability of heavier receptors.

*Weight limit for both Series-B and Series-C is 22-lbs.*

See additional specs on page 32.



## Mobile Tilt & Rotate Extending Arm Receptor Holders

Extends image receptors 11" to 23" from post. See additional specs on page 32.

*Heavy DR receptors may pose a tipping risk when fully extended. Extended weight limit for both Series-B and Series-C is 12-lbs.*

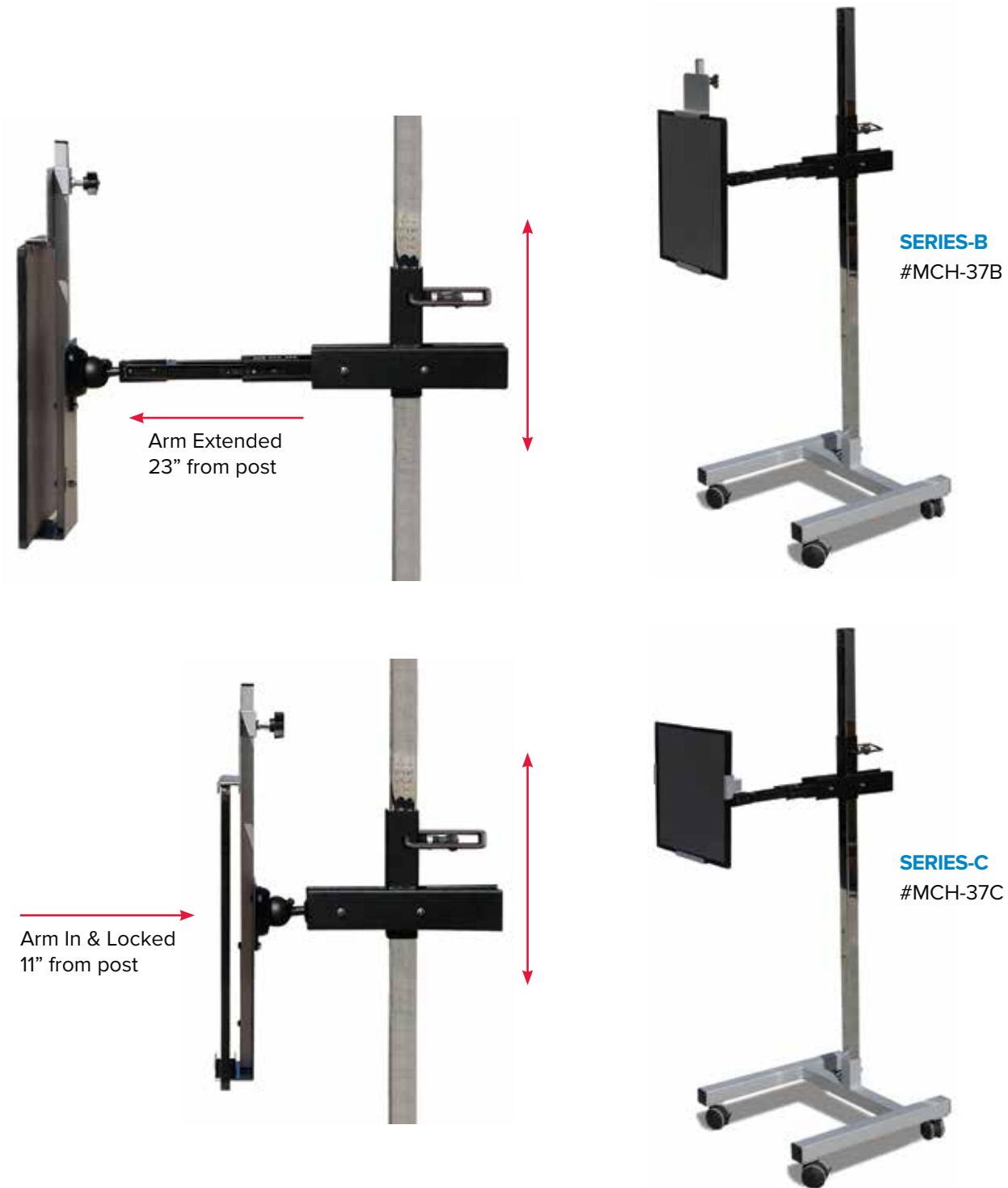

## 2-Step Weight Bearing Platform

Allows for weight bearing imaging of the knees, ankles, and feet. Three receptor slots on the top platform and two slots on the bottom platform. 52" high safety rail provides for patient stability. Choose from two platforms: Comfort Top: gray, high-density crosslink closed cell foam for comfort and support. Durability Top: black, high-density, solid polyethylene with anti-slip matting. 350-lb. weight capacity. Platform heights: 11½" and 16¼". All steel frame with 30"l x 20"w base.



Comfort Top  
#WMP-16  
Ships@ 105 lbs

Durability Top  
#WMP-22  
Ships@ 160 lbs

## AP Weight Bearing Receptor Protectors

Provides supportive platform when patient is required to stand on the receptor. Accommodates DR, CR, and analog panels. Supports patients up to 800-lbs. Frame is resilient aluminum with a clear polycarbonate support surface. Includes an easy-lift handle.

Perfect for Ortho, Podiatry, and Bariatrics.



cat. #	receptor size	receptor style
WBC-0810W	8" x 10"	cassette or wireless panel
WBC-1012W	10" x 12"	cassette or wireless panel
WBC-1417W	14" x 17"	cassette or wireless panel
WBC-1417T	14" x 17"	tethered DR panel
WBC-1717T	17" x 17"	tethered DR panel
WBC-1417CF	14" x 17"	carbon fiber wireless
WBC-1417CFT	14" x 17"	carbon fiber tethered DR

**New Carbon Fiber Protector!**

### 3-Step Weight Bearing Platform

Designed for tube stands that don't go low enough. Three receptor slots on the top platform and two slots on the middle platform. 59" high safety rail provides for patient stability. Choose from two platforms: Comfort Top: gray, high-density crosslink closed cell foam for comfort and support. Durability Top: black, high-density, solid polyethylene with anti-slip matting. 350-lb. weight capacity. Platform heights: 8½", 19½" , and 23". All steel frame with 42"l x 20"w base.



Comfort Top  
#WMP-14  
Ships@ 158 lbs

Durability Top  
#WMP-28  
Ships@ 200 lbs



Clear coated crosslink foam comfort top.



Solid HD polyethylene durability top.



Forward and side handrails for patient stability.



Rear wheels for easy tilt & go.



Lower Channel is 1¼" wide to accommodate different receptors and Upper Channel is 1¼" wide to accommodate GE Flash Pad.

### Weight Bearing Receptor Holder

Economical solution for weight bearing examinations. Crosslink closed cell foam is coated for durability and easy cleaning. Overall size: 17½" x 11½" x 4".

Cat.#YCWB



## Panel Protectors



Protect your investment with our DR Panel Protectors. Each protector contains three layers of your choice of impact-resistant material or carbon fiber for increased weight capacity. These protectors are designed for both tethered and wireless panels, and also include custom utility ports. Includes rounded corners for safe handling and the patented positive lock mechanism to prevent accidental panel pop-outs. Lightweight design makes for easy carrying and one-handed operation.

cat. #	description
WBP-LA1417	handle on long side, plus accessory handle
WBP-LA1417-CF*	handle on long side, plus accessory handle
WBP-SA1417	handle on short end, plus accessory handle
WBP-SA1417-CF*	handle on short end, plus accessory handle
WBP-S1417	handle on long side
WBP-S1417-CF*	handle on long side
WBP-T1417	handle on short end
WBP-T1417-CF*	handle on short end

\*(Includes **Carbon Fiber** Insert)  
NOTE: Not for use with panels with built-in handles.



## Mobile Imaging Caddy

Keep everything at your fingertips for mobile imaging. Conveniently hangs from mobile imager mast. Large pouch for Receptor Covers. Medium pouch for accessories. Two small pouches for markers, pens, and other small items. Heavy gauge, reinforced vinyl with clear outer pockets. Caddy is 11”w x 16”h with a strap that extends to 24”.

#PMA-C4



Other accessories are sold separately.



No Image Compromise!

## Protect Your Investment!



Shown:  
five 100-pc boxes  
inside one 500-pc case

Compact Dispenser  
Box of 100 covers

## CR/DR/Film Receptor Covers

Disposable; prevents cross-contamination. Keeps receptors clean and dry from exposure to bodily fluids, solutions, plaster, etc. Specifically designed to fit your imaging receptors. Non-sterile. Latex-Free! 2 mil polyethylene is transparent to x-ray. Can also be used to cover positioning sponges. Available in Standard Overlock and Ziplock™ closures.

### Standard Flip-Lip Closure

Allows safe handling and positioning of: CR-Receptors, Cassettes, and DR-Receptors. \*Fits 23" x 25" DR-Receptors with Grids!

cat. #	fits receptor size	quantity
CCS-08	8" x 10"	1 box of 100
CCS-10	8" x 10"	1 case of 500
CCM-10	10" x 12"	1 box of 100
CCM-12	10" x 12"	1 case of 500
CCL-14	14" x 17"	1 box of 100
CCL-17	14" x 17"	1 case of 500
CCC-DR	20" x 20"	1 box of 100
CCD-DR	20" x 20"	1 case of 500
CCXL-24*	23" x 25"	1 box of 100
CCXL-26*	23" x 25"	1 case of 500

**Ships Next Business Day!**



### Ziplock™ Closure

Disposable bag securely seals in image receptors. Provides Maximum Protection from cross contamination. \*Fits 23" x 25" DR-Receptors with Grids!

cat. #	fits receptor size	quantity	
CCZ-14	14" x 17"	1 box of 100	(2 mil)
CCZ-17	14" x 17"	1 case of 500	(2 mil)
CCXZ-24*	23" x 25"	1 box of 100	(2 mil)
CCXZ-26*	23" x 25"	1 case of 500	(2 mil)
CCH-24*	23" x 25"	1 box of 100	(4 mil)
CCH-26*	23" x 25"	1 case of 500	(4 mil)

## INTRODUCING Plastic Bag Dispensing

We realize that some facilities cannot accept products in corrugated cartons. This assortment of Receptor Covers is provided in quantities of 100 covers per dispensing bag to meet those requirements and keep your supply clean and organized. These covers are the very same styles and quality as our originals shown above.

**NEW!**  
**Plastic Bag**  
**Dispensing**

cat. #	fits receptor size	quantity	
<b>STANDARD BAGS</b>			
CCL-14-B	14" x 17"	1 bag of 100	(2 mil)
CCC-DR-B	20" x 20"	1 bag of 100	(2 mil)
CCXL-24-B*	23" x 25"	1 bag of 100	(2 mil)
<b>ZIPLOCK™ BAGS</b>			
CCZ-14-B	14" x 17"	1 bag of 100	(2 mil)
CCXZ-24-B*	23" x 25"	1 bag of 100	(2 mil)
CCH-24-B*	23" x 25"	1 bag of 100	(4 mil)



## Standard Step Stools

All steel 350-lb. capacity. Skid resistant black mat. 9" high stool with 11" x 13<sup>3</sup>/<sub>4</sub>" top; 34" tall with handrail. Handrail is 7/8" dia. chrome-plated tubular steel. Easy assembly. Shipping weight: stool 8 lbs.; handrail 4 lbs.



## Heavy Duty Step Stools

Bariatric 600-lb. capacity. Steps have a skid resistant black mat surface. Height: Single Step: 8<sup>3</sup>/<sub>4</sub>" high step; 34<sup>1</sup>/<sub>2</sub>" with handrail. Double Step: 8" & 16" high steps; 43" with handrail. Handrail is 1" dia. chrome-plated 16g steel. Shipping weight: Single Step: stool 8 lbs.; handrail 6 lbs. Double Step: stool 20 lbs.; handrail 5 lbs.



## Bariatric Step Stools

Bariatric 1000-lb. capacity. Step has anti-slip gripper strips. Flared base legs to prevent tipping. Step Only: 19" long x 15" wide x 8" high. Handrail model height is 36". Shipping weight: stool 11 lbs.; handrail 8 lbs.

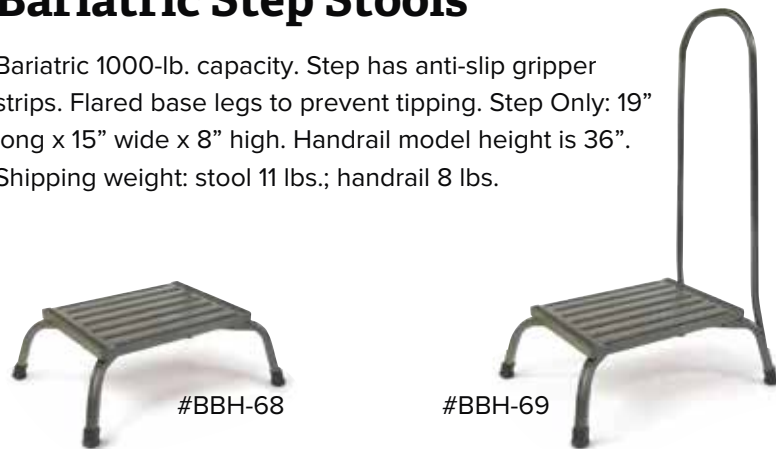

#BRF-45

Set of four (4) rubber tips for standard and bariatric step stools. Also fits BAS-30 stool.



## Step Platforms

Large area platforms offer superior patient stability. Laminated high pressure hardboard. Step has non-slip tread.





Economy  
Twist Lock

2-Hook  
#BIV-70

Ships @  
17 lbs.

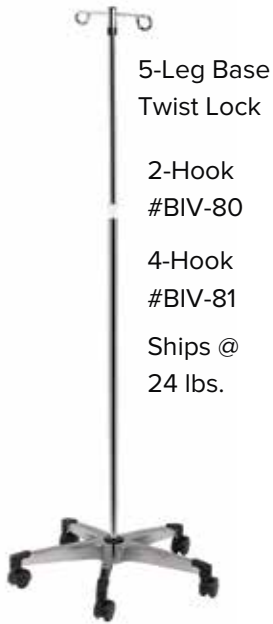

5-Leg Base  
Twist Lock

2-Hook  
#BIV-80

4-Hook  
#BIV-81

Ships @  
24 lbs.



5-Leg Base  
Knob Lock

2-Hook  
#BIV-76

4-Hook  
#BIV-77

Ships @  
25 lbs.

## IV Stands

NEW 5-Leg base poles safety approved. 1" and 7/8" telescoping, chromed steel tubes. Height range: 46"-83". Base diameter: economy 22"; 5-Leg 23". 5-Leg bases have scuff guard tips. Two or four rams-horn style IV hooks.



Tableside

#BMS-80  
Ht: 34"-54"  
Ships @ 19 lbs.



Mobile

#BMS-95  
Ht: 31"-50"  
Ships @ 17 lbs.  
in two boxes

## Instrument Stands

Provides ready access to equipment or instruments. Leg posts are 1" chrome plated steel. Steel, easy-slide extension posts. Stainless steel tray is 12" x 19" x 3/4" deep.

## Hampers

### Tilt-Lid Hampers

Lidded hampers provide sanitary environment for soiled linens. Durable, epoxy coated steel lid. Pedal activated lid with lid prop. Chrome plated steel frame. 3" rubber wheel casters.



#BHS-10 (WHITE LID)  
#BHS-20 (RED LID)  
Ships @ 27 lbs.



### Folding Hamper

Adjustable for 18", 22", or 25" bags. Chrome plated steel frame. 3" rubber wheel casters.

#BHF-10  
Ships @ 18 lbs.



### Hamper Bags

Drawstring hamper bags for all models.  
#BAG-35 (35-gallon capacity)  
#BAG-45 (45-gallon capacity)

## Standard Exam Lamp

Flexible gooseneck arm with 360° adjustable steel shade. Chrome steel stand has adjustable height range: 50" to 74". Uses one 60-watt incandescent bulb (not included). Weighted stationery base or 23" diameter mobile base. Weight: 7 lbs.

#BEL-90



Inner shade keeps outer shade cool

## Halogen Exam Lamp

Flexible gooseneck arm with 540° adjustable head. Beige enamel coated steel stand is adjustable to 65½". Uses one high intensity 35-watt halogen lamp (incl.). 1500 Footcandles @ 24"; 3000° Kelvin. Weighted stationery base or 18" diameter mobile base.

#BEH-93



#BEH-91



Heat sink technology keeps light housing cool

## Pneumatic Lift Stool with Locking Casters

Pneumatic gas cylinder easily adjusts height with convenient under-cushion ring. Adjustable height: 16" to 21". 16" x 3.5" thick seat cushion. 5-leg, chrome base. Reverse casters auto-lock when seated. 23" base provides excellent stability. Weight: 27 lbs.; Ships @ 33 lbs.

#BPS-30



## Pneumatic Lift Stool with Backrest

#BPS-32

(BPS-30 with adjustable backrest and paddle height lever)



**BPS-30 & BPS-32 ONLY:**  
choose fabric or vinyl  
on page 117

## Spin-Lift Adjustable Stool 5-Leg

Solid steel, machined thread screw adjusts height by rotation of the stool cushion. Adjustable height: 18" to 22". 16" x 4" thick seat cushion. 5-leg, die cast aluminum base. 23" base provides excellent stability. Weight: 17 lbs.; Ships @ 30 lbs.



#BAS-40



## Spin-Lift Adjustable Stool 4-Leg

Solid steel, machined screw adjusts height by rotation of the stool cushion. Adjustable height: 19" to 25½". 14½" x 4" thick seat cushion. 4-leg chrome steel base with footring. Weight: 18 lbs.; Ships @ 30 lbs.

#BAS-30



## Pneumatic Lift Stool

Pneumatic gas cylinder easily adjusts height with convenient under-cushion ring. Adjustable height: 19" to 24". 16" x 4" thick seat cushion. 5-leg, die cast aluminum base. 23" base provides excellent stability. Weight: 20 lbs.; Ships @ 30 lbs.

#BPS-20



## Pneumatic Lift Stool with Backrest

#BPS-22

(BPS-20 with adjustable backrest and D-ring height lever)



## Silk Screened Signs

All signs are constructed of 1/8" thick Trovicel™. Double-faced tape is attached to the back of each sign for mounting. Large Signs are 8" x 10". Small Signs are 4" x 10". The large MRI "Danger" Signs are 12" x 18".



#NFD-22B



#NFD-22R

## English



#NCP-24B



#NCP-24R



#PS-04EB



#PS-04ER



#CXR-13EB



#CXR-13ER

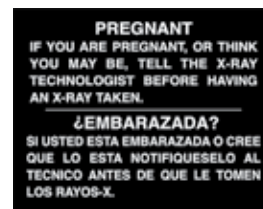

#PS-08B

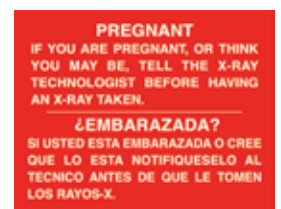

#PS-08R



#XRR-19B



#XRR-19R

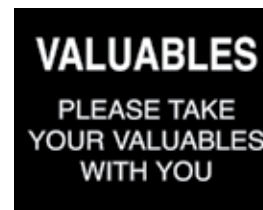

#VS-10EB

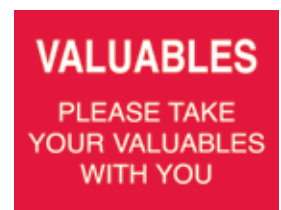

#VS-10ER



#CDK-11B



#CDK-11R

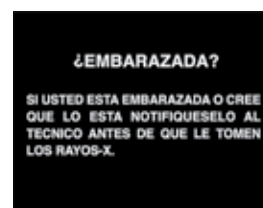

#PS-04SB

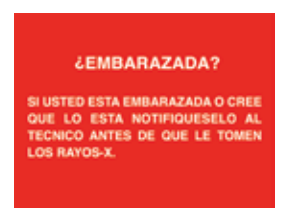

#PS-04SR

## Spanish



#CXR-13SB



#CXR-13SR

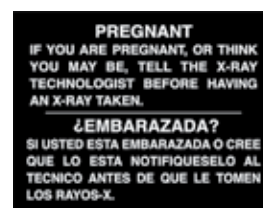

#PS-08B

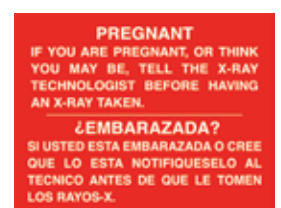

#PS-08R



#CDR-12B



#CDR-12R

## Caution / MRI Signs

Signs give critical information to patients & technologists. Enhances safety with a front line written warning. Many states adopt certain signs as law. Part of a good quality assurance program. Check your local laws or program requirements. Custom signs available for quote (best price with multiples).



Large Signs are 8" x 10".  
Small Signs are 4" x 10".  
The large MRI "Danger" signs are 12" x 18".



#CRA-15



#CMF-01

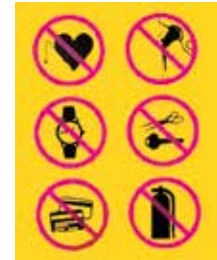

#CMM-06



#CRA-16



#MBN-13E



#MBN-14S



#CRA-17



#CRA-18



#MBN-15E



#MBN-16S

## Custom Engraved Signs

Engraved 1/16" thick Rowmark™. Stock colors: White letters in Red plate, White letters in Black plate, Red letters in Yellow plate. Double-faced tape attached to the back for mounting. Letters and numbers only; no symbols. Other unusual sizes and styles available for quote.

size	cat.#
48 sq. inches or less	SI-48
over 48 sq. in. and up to 144 sq. in.	SI-144

Example Sign



Example: 5" x 9" = 45 sq. in.  
#SI-48

## Aquasonic® 100

industry standard ultrasound transmission gel

Recommended for all procedures where a viscous gel is required. Acoustically correct for the broad range of frequencies used. Aqueous formula will not stain clothing or damage transducers. Hypoallergenic, bacteriostatic, non-sensitizing, non-irritating.

cat. #	size per unit	units/box
USO-025	250ml bottle	12
USO-100	1 liter bottle	6
USO-500	5 liter jug w/bottle	1
USO-048	20g sterile pouch	48



## Aquasonic Clear®

same as Aquasonic® 100, but with no fragrance or color

Recommended for all procedures where a viscous gel is required. Acoustically correct for the broad range of frequencies used. Aqueous formula will not stain clothing or damage transducers. Hypoallergenic, bacteriostatic, non-sensitizing, non-irritating.

cat. #	size per unit	units/box
USC-025	250ml bottle	12
USC-100	1 liter bottle	6
USC-500	5 liter jug w/bottle	1



## Empty Dispenser Bottles

Standard 250ml bottles can be used for ready refills or as a back-up supply when filled from a larger container. Comes with a black tip cap and can be used in ultrasound gel warmers.



#USB-012  
sold/dozen

## Ultrasound Probe Covers

Acoustically transparent, minimizing distortion during scanning. Available in Latex or Latex-Free and Sterile or Non-Sterile. A variety of style and sizes for many applications and specialties: Radiology, Vascular, Cardiology, Urology, Phlebology, Emergency Medicine, OB/GYN, etc.

cat. #	description	dia. x length	qty/case
<b>LATEX PROBE COVERS, NON-STERILE</b>			
USP-LN01CS	condom size, bulk pack	1.25" x 8"	1200
USP-LN03CS	condom size, individually wrapped	1.25" x 8"	1200
USP-LN04CS	extra-long, bulk	1.18" x 11.8"	600
<b>LATEX-FREE PROBE COVERS, NON-STERILE</b>			
USP-FN03CS	rolled, individually wrapped	1" x 9"	600
USP-FN04CS	extra long, individually wrapped	1" x 12"	600
<b>LATEX-FREE PROBE COVERS, STERILE</b>			
USP-FS01CS	semi-rolled and tapered, bulk pack	1" d x 9"	300
USP-FS02CS	semi-rolled, wide abdominal	3.5" flat x 12"	75



Now sold by the CASE!

## Elemental Ultrasound Stool

Sit in comfort during extended ultrasound procedures. Back height adjustment. Tilting backrest. Pivot backrest. Tilting seat. Warranty: 7-year limited. Seat: 19”w x 19”d. Back:19”w x 17.5”h. Seat height range: 23”-33”. Overall height: 42”-55”. 20” chrome footring. Ships @ 68# (actual wt. 46#)

Fabrics on page 117



Cat. #ZOES-MX03

See page 59 for Ultrasound positioning sponges.

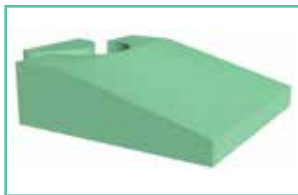

## Anti-Fatigue Floor Mat for Sonographers

Provides comfort for standing during long exams. Blown vinyl-nitrile sponge base provides superior cushioning, while a solid vinyl-nitrile surface provides sure-footed protection from wear and tear. This 2’ x 3’ x 1/2” black mat comes with a 1-year warranty.

#TM-51323



## Ultrasound Gel Warmers

fits standard 250ml gel bottles

### Steel Gel Warmers

“Uni-Sleeve” heating element adjusts up to 122°F. Illuminated On/Off switch with hospital grade cord. Stainless Steel with white powder coat finish. 5”w/8”w/11”w x 6”d x 5”h.

cat. #	rating	capacity
UGW-UO1	UL/CSA approved	1
UGW-UO2	UL/CSA approved	2
UGW-UO3	UL/CSA approved	3



### Composite Gel Warmers

Maintains constant temperature. Impact-resistant composite housing. Hospital grade power cord. Three Bottle Unit ONLY: - Illuminated On/Off switch. - Energy-saving lid. - 3-position thermostat (UGP-UL3): Low: 97°F / Medium: 102°F / High: 109°F. - Digital display thermostat (UGP-ULD): 1° increments from 97°F to 109°F. Single bottle unit is factory set at 104°F with a heat indicator lamp.

cat. #	rating	capacity
UGP-UL1	UL/CSA approved	1
UGP-UL3	UL/CSA approved	3
UGP-ULD	UL/CSA approved	3



Counter Top or Wall Mount





## MRI Furniture

Each piece is non-magnetic and safe to use in the MRI environment. Some weights do not reflect OverSize UPS/FedEx Rate.

-  = MR Conditional (no hazards up to 3-Tesla);
-  = MR Safe (no known hazards);
-  = MR Unsafe (danger/known hazard).

### MRI Step Stool w/ Handrail

Stainless steel construction. 500# weight capacity. Step: 16”w x 12”d x 8½”h. Handrail height: 41”. “MRI Green” mat; rubber tips. Ships @ 13 lbs (+oversize) UPS/FedEx.



#MBS-65



### MRI Two-Step Platform Stool w/ Handrail

Stainless steel. 400# weight capacity. Top Step: 36”w x 12”d x 16”h, Bottom Step: 36”w x 12”d x 8”h. Handrail height: 41”. “MRI Green” mat; rubber tips. Ships @ 48 lbs, motor freight.



#MBD-68



### MRI Chairs & Stools

Screw-post height adjustment. 4” padded seat. Seat upholstered in “MRI Green.” Ships via UPS/FedEx.



cat. #	height range	features	base	ship wt.
--------	--------------	----------	------	----------

**CHAIRS**

MBC-30CC	17”-23”	chair only	casters	22
MBC-31CC	17”-23”	chair+back	casters	24
MBC-30CT	15”-21”	chair only	tips	22
MBC-31CT	15”-21”	chair+back	tips	24

**STOOLS**

MBC-30SC	23”-29”	stool only	casters	22
MBC-31SC	23”-29”	stool+back	casters	24
MBC-30ST	21”-27”	stool only	tips	23
MBC-31ST	21”-27”	stool+back	tips	25

### MRI IV Pole

Extends from 48” to 92½”. 24” diameter base. 2” swivel casters. Ships via UPS/FedEx: Pole @ 3 lbs, Base @ 7 lbs.

cat. #	description
MBI-70	2-hook iv pole
MBI-75	4-hook iv pole



## MRI Wheel Chairs

24" diameter wheels, 8" front casters. Burgundy upholstery. Smooth ride, rust-proof hand rims. Retractable wheel locks. Quick release seat belt. Sling style seat (bariatric: solid padded seat). Ships via UPS/FedEx (bariatric: motor freight).



cat. #	seat width	overall	weight cap.	ship wt.
MBW-18	18"	26"	250#	53
MBW-20	20"	28"	250#	55
MBW-22	22"	30"	350#	62
MBW-24	24"	30"	350#	62
MBW-24B	24"	35"	550# bari.	67 & 13
MBW-26B	26"	35"	550# bari.	67 & 13
MBW-10	I.V.Pole & O <sub>2</sub> E-tank mount			7



Standard MRI Wheel Chairs



Bariatric Wheel Chairs



"MR" is on the back of every chair.

## MRI PVC Transport Gurney

Economic PVC construction. Three weight capacities. Features flip-down side rails. Three position backrest. 79"l x 28"w x 33½". Four locking casters, two or four stationary. Either ships @ 150 lbs, motor freight.



350# CAPACITY  
#MBG-3PV

600# CAPACITY  
#MBG-6PV



## MRI Transport Gurney

600# weight capacity. Stainless steel construction. Features flip-down side rails. Backrest adjusts from 0° to 75°. Non-marring bumper pads. 70"l x 30"w x 39"h. Four locking casters. Ships @ 300 lbs, motor freight.



#MBG-6SS (HEAVY DUTY)

Options for MBG-6SS:  
IV Pole Attachment #MBG-IV  
O<sub>2</sub> Tank Holder #MBG-O2



## MRI Positioning Sponges

### LEG REST WITH KNEE CUTOUTS

Provides leg and knee support while maintaining hip flexion. Reduces back stress. Cleanable coating.

#YMCP (Large)  
(patients > 6' tall)  
18 x 24 x 10

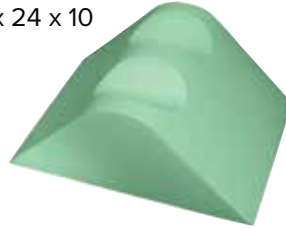

#YMCM (Medium)  
(patients 5'-6' tall)  
12½ x 16¼ x 7

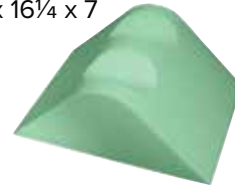

#YMCS (Small)  
(patients < 5' tall)  
14½ x 18 x 4



*Additional MRI positioners and table pads can be found on page 67.*

### MRI COMFORT PILLOW

Gently elevates head during MRI & CT exams. Includes handhold straps. 16 x 25 x 8¼. Nylon covering.

#YVfV



### ADJUSTABLE LEG POSITIONER

Specifically designed for RADIUS table tops. Removable pads allow three different knee heights. Cleanable coating.

#MCP-AP



## MRI Warning Signs

Durable plastic silk-screened signs. Double-faced tape is on the back for mounting. Additional signs are available on pages 50 & 51.

MR	cat. #	sign #	description	size
	CMF-01	A	yellow, 1 symbol	8"x 10"
	CMM-06	B	yellow, 6 symbols	8"x 10"
	MBN-13E	C	restricted access (Eng)	12"x 18"
	MBN-14S	D	restricted access (Sp)	12"x 18"



## MRI Earplugs

Economical protection. Latex-free. Use w/ headset or alone. Bulk packaged as 1000 pcs.



NRR: 29db  
#MBE-29



NRR: 33db  
#MBE-33



## Metal Detector

Save patients and staff from embarrassing and hazardous situations. Features large scan surface w/ sensitivity reduction switch. Ships @ 15 lbs, UPS/FedEx.



#MBM-MD

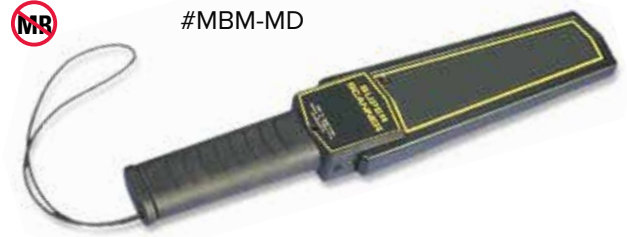

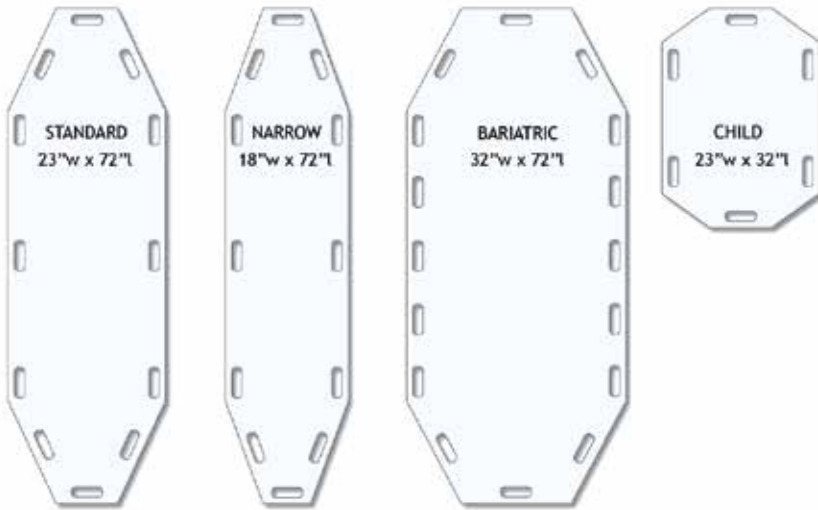

## MRI Transfer Boards

Allows safe and efficient transfer of patients for general imaging, MRI, and CT. Durable, semi-rigid, slick material makes positioning under the patient easy. Transfer boards are radiolucent can be used in the imaging field. Conveniently located 1½” x 4½” hand-holds allow optimal movement. Regular Boards are made of 3/16” thick HDPE (high density polyethylene). Regular board color is white. Transfer boards ship at OverSize rates.



### REGULAR BOARDS (white)

cat. #	description
TBS-2372	standard
TBN-1872	narrow
TBB-3272	bariatric
TBH-2332	half

### ANTI-STATIC BOARDS (black)

cat. #	description
TBS-2372AS	standard
TBN-1872AS	narrow
TBB-3272AS	bariatric
TBH-2332AS	half

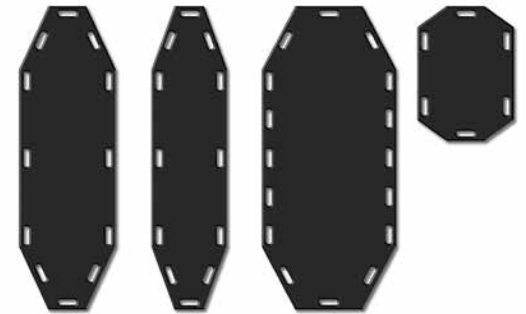

## MRI Non-Ferromagnetic Sandbags



Custom upholstered sandbags with supportive handles help with patient positioning. Non-ferrous, non-magnetic, MRI Safe bags come in five weights in order to provide the ideal set-up. Order individual bags or one set that includes one of each size bag for a total of five bags.



Set of All Five Bags  
#MSB-NFST



# Revolutionary Design Minimizes Ghosting and Line Artifacts!



**Stealth-Core™** sponges have been designed with unique angles to offer artifact-free viewing and increased stability.



**Stealth-Cote™** sponges include a proprietary coating to add cleanability and durability to every sponge and includes antimicrobial protection.  
(The **Stealth-Core™** and **Stealth-Cote™** sponges are Patent Pending.)

## Stealth Rectangle Positioning Sponges

Overall dimensions: width X length X height.  
May be larger than traditional style.



#YFBL



3" RECTANGLE  
BASE: 10.25 X 12.5 X 3  
TOP: 7.5 x 10



#YCBL

#YFBN



3" RECTANGLE  
BASE: 16.5 X 20.5 X 3  
TOP: 14 x 18



#YCBN

#YFBO



4" SQUARE SPONGE  
BASE: 13.5 X 13.5 X 4  
TOP: 10 x 10

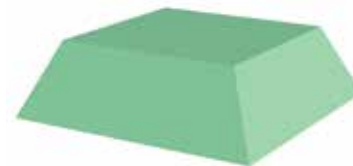

#YCBO

#YFBY



4" SQUARE SPONGE  
BASE: 21.5 X 27.5 X 4  
TOP: 18 x 24

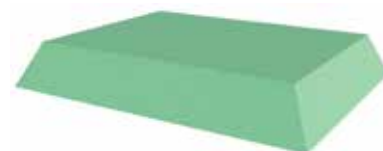

#YCBY

# Non-Stealth Traditional Rectangle Sponges

Overall dimensions: width X length X height.

## Standard Uncoated

## Standard Coated

#YFGG



1.5" RECTANGLE  
8 X 18 X 1.5



#YCGG

#YFEO



1.5" RECTANGLE  
14 X 21 X 1.5

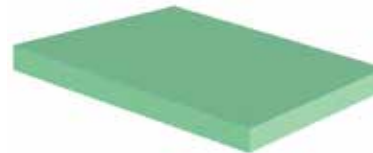

#YCEO

#YFEM



2.5" RECTANGLE  
15 X 24 X 2.5

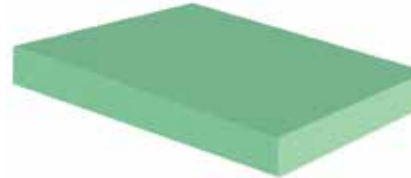

#YCEM

#YFBR



1" RECTANGLE  
4 X 6 X 1

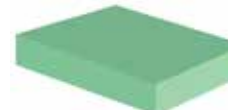

#YCBR

#YFBS



1.5" RECTANGLE  
4 X 6 X 1.5



#YCBS

#YFBT



2" RECTANGLE  
4 X 6 X 2

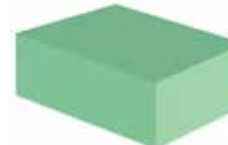

#YCBT

#YFBV



2" RECTANGLE  
6 X 6 X 2



#YCBV

#YFEH

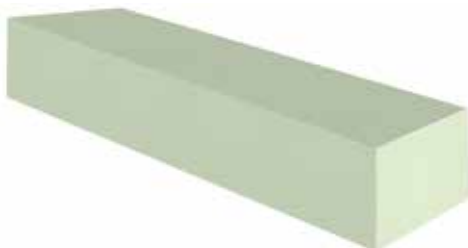

4" RECTANGLE  
5.5 X 20 X 4

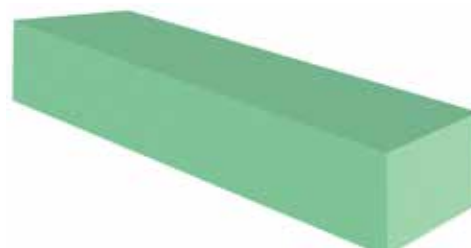

#YCEH

## Stealth Wedge Positioning Sponges



Overall dimensions: width X length X height.  
May be larger than traditional style.



#YFBE		34° WEDGE (SET OF 2) 5.5 X 9.75 X 3		#YCBE
#YFBH		16° WEDGE (SET OF 2) 8.5 X 11 X 3.5		#YCBH
#YFBI		15° WEDGE (SET OF 2) 12.5 X 10 X 3		#YCBI
#YFBJ		12° WEDGE (SET OF 2) 10.5 X 9.25 X 2.25		#YCBJ

## Non-Stealth Traditional Wedge Sponges

Overall dimensions: width X length X height.



















**Standard Uncoated**

**Standard Coated**

#YFFD		45° SPINAL WEDGE 7 X 21 X 7		#YCFD
#YFDA		45° CARDIAC WEDGE 14 X 28 X 14		#YCDA
#YFDB		30° CARDIAC WEDGE 28 X 27 X 16		#YCDB
#YFCL		21° EPIDURAL WEDGE 24 X 27 X 7		#YCCL
#YFEG		65° WEDGE 16 X 25 X 8.25		#YCEG

# Stealth Wedge Positioning Sponges



#YFEA		45° SPINAL WEDGE UNCOATED: 13.75 X 24 X 9.5 COATED: 13.75 X 33 X 9.5		#YCEA
#YFEB		45° SPINAL WEDGE 10.5 X 30 X 7.5		#YCEB
#YFEE		45° ECHOCARDIOGRAPHY WEDGE UNCOATED: 13 X 30 X 9 COATED: 13 X 38.25 X 9		#YCEE
#YFBD		45° SPINAL WEDGE 10 X 27.75 X 7		#YCBD
#YFBB		45° WEDGE 10 X 20.25 X 7		#YCBB
#YFBC		45° WEDGE 10 X 13.5 X 7		#YCBC
#YFBU		30°-60°-90° MULTI-ANGLE 10 X 29.5 X 6		#YCBU
#YFBF		27° WEDGE 12.75 X 15.5 X 6		#YCBF
#YFBG		21° WEDGE 12.25 X 14.25 X 4.5		#YCBG



# Stealth Extremity Positioning Sponges

Overall dimensions: width X length X height.  
May be larger than traditional style.



#YFAA



ADULT OBLIQUE  
FINGER BLOCK



#YCAA

#YFAB



BILATERAL ADULT  
OBLIQUE FINGER BLOCK



#YCAB

#YFAC



BILATERAL PEDIATRIC  
OBLIQUE FINGER BLOCK



#YCAC

#YFAD



ADULT LATERAL  
FINGER BLOCK



#YCAD

#YFAE



PEDIATRIC LATERAL  
FINGER BLOCK



#YCAE

#YFAH



KNEE ARTHROGRAM BLOCK  
14.5 X 19 X 8



#YCAH

#YFAJ



CT KNEE WEDGE SUPPORT  
22 X 20 X 7



#YCAJ

#YFCB



MEDIUM EXTREMITY BLOCK  
11.5 X 19.75 X 5



#YCCB

#YCNZ



15° PODIATRY AXIAL / SESAMOID  
8 X 13 X 4  
CLOSED CELL FOAM with CLEAR COAT  
(For viewing metatarsals, sesamoids,  
and plantar condyles)



# Stealth Head/Neck Positioning Sponges

Overall dimensions: width X length X height.  
May be larger than traditional style.



#YFAK



CIRCULAR HEAD BLOCK  
BASE: 9dia. X 1.5  
TOP: 7dia.



#YCAK

#YFAL



HEAD & NECK SUPPORT  
14.5 X 16 X 6.5



#YCAL

#YFAM



AP/PA ADULT HEAD HOLDER  
14 X 15 X 6.75



#YCAM

#YFAN



AP/PA CHILD HEAD HOLDER  
9.5 X 11 X 5



#YCAN

#YFAP



ADULT HEAD IMMOBILIZER  
9 X 15.25 X 7



#YCAP

#YFAQ



CHILD HEAD IMMOBILIZER  
6.75 X 11.5 X 5.25



#YCAQ

#YFAR



CERVICAL HEAD REST  
7.5 X 16 X 4.5



#YCAR

## Bariatric Stealth Positioning Sponges

Overall dimensions: width X length X height.  
May be larger than traditional style.

HIGH-DENSITY SPONGE: These positioning blocks are specifically designed to provide extra firm support for bariatric and athletic patient positioning.



#YBAT



BARIATRIC TORSO BOLSTER  
18.5 X 16.5 X 7



#YCAT

#YBBA



BARIATRIC 45° SPINAL WEDGE  
10 X 27.5 X 7



#YCBA

#YBBM



BARIATRIC RECTANGLE  
BASE: 10.5 X 14.5 X 3  
TOP: 8 x 12



#YCBM

#YBBP



DECUBITUS PAD  
BASE: 21.5 X 27.5 X 4  
TOP: 18 x 24

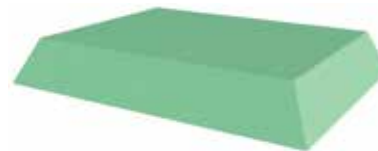

#YCBP

#YFEU



BARIATRIC 30°-60°-90° WEDGE  
10 X 29.5 X 6

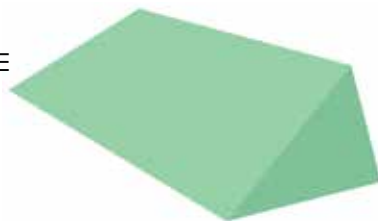

#YCEU

## Non-Stealth Traditional Bariatric Wedges

Overall dimensions: width X length X height.

Standard Uncoated

Standard Coated

#YFCG



45° BARIATRIC WEDGE  
9 X 30 X 9



#YCCG

#YFHB



BARIATRIC SPINAL WEDGE  
7 X 24 X 5







#YCHB

## Specialty Stealth Positioning Sponges

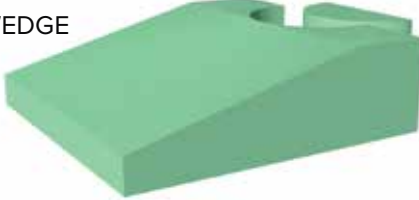



Overall dimensions: width X length X height.  
May be larger than traditional style.

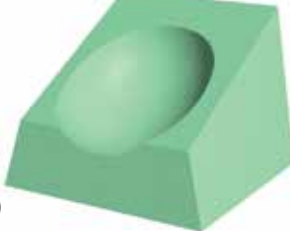

#YBUZ		ENDO-ULTRASOUND WEDGE 20 X 20 X 6		#YCUZ
#YFEQ		PERINEAL WEDGE 20 X 20 X 3		#YCEQ
#YFAY		ANGULAR BOLSTER 14 X 22.5 X 7.25		#YCAZ

## Coated-Only Stealth Specialty Sponges

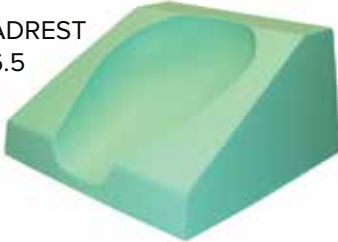
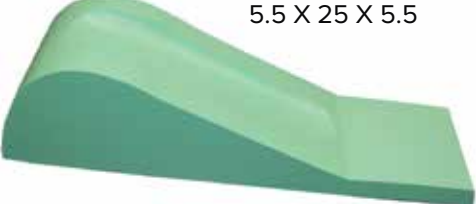
Overall dimensions: width X length X height.

#YCET		CT/CATH LAB HEADREST 12.75 X 13 X 4.5 (Neck Cradle 3" h)		#YCBW
#YCEV		CONVERTIBLE CT HEADREST 14 X 13.5 X 6.75 (2-Pc Flat and Convex Bases)		#YCEW
#YCEZ		PHLEBOTOMY WEDGE 5.5 X 25 X 5.5		#YCMG

# General Sponge Kits

Overall dimensions: width X length X height.  
May be larger than traditional style.



#YKGP



**GENERAL KIT P**  
Uncoated OR Coated Kit includes:

uncoated	description	coated
YFBD	45° Spine Wedge	YCBD
YFBI	15° Wedge	YCBI
YFAK	Circular Head Block	YCAK
YFAA	Oblique Finger Block	YCAA



#YSGP

#YKGA

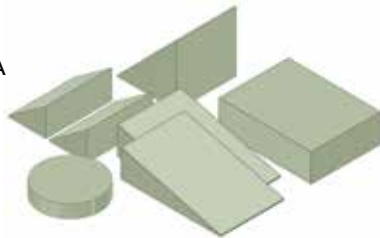

**GENERAL KIT A**  
Uncoated OR Coated Kit includes:

uncoated	description	coated
YFAK	Circular Head Block	YCAK
YFBC	45° Wedge	YCBC
YFBE	(2) 34° Wedges	YCBE
YFBI	(2) 15° Wedges	YCBI
YFBL	Rectangle	YCBL

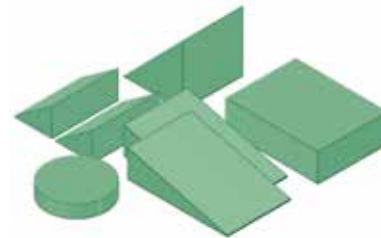

#YSGA

#YKGB



**GENERAL KIT B**  
Uncoated OR Coated Kit includes:

uncoated	description	coated
YFAA	Adult Obl Finger Block	YCAA
YFAK	Circular Head Block	YCAK
YFBC	45° Wedge	YCBC
YFBI	(2) 34° Wedges	YCBE
YFBI	(2) 15° Wedges	YCBI
YFBJ	(2) 12° Wedges	YCBJ
YFBL	Rectangle	YCBL



#YSGB

#YKGD

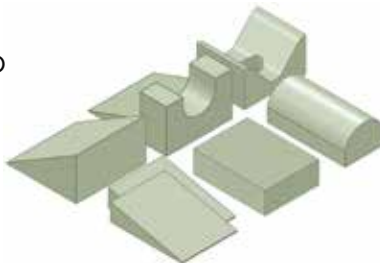

**GENERAL KIT D**  
Uncoated OR Coated Kit includes:

uncoated	description	coated
YFAL	Head & Neck Support	YCAL
YFAN	AP/PA Child Head Holder	YCAN
YFAR	Cervical Head Rest	YCAR
YFBF	27° Wedge	YCBF
YFBJ	(2) 12° Wedges	YCBJ
YFBL	Rectangle	YCBL



#YSGD

#YKGE



**GENERAL KIT E**  
Uncoated OR Coated Kit includes:

uncoated	description	coated
YFAA	Adult Obl Finger Block	YCAA
YFAK	Circular Head Block	YCAK
YFAM	AP/PA Adult Head Holder	YCAM
YFBB	45° Wedge	YCBB
YFBG	21° Wedge	YCBG
YFBI	(2) 15° Wedges	YCBI
YFBL	Rectangle	YCBL
YFBN	Rectangle	YCBN
YFBU	Multi-Angle Wedge	YCBU



#YSGE

#YKGX

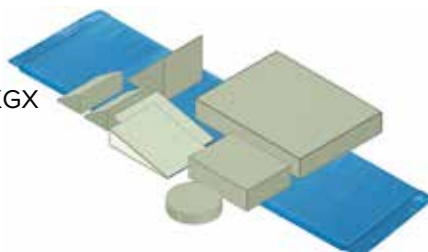

**GENERAL KIT X**  
Uncoated OR Coated Kit includes:

uncoated	description	coated
YFAK	Circular Head Block	YCAK
YFBC	45° Wedge	YCBC
YFBE	(2) 34° Wedges	YCBE
YFBJ	(2) 12° Wedges	YCBJ
YFBL	Rectangle	YCBL
YFBN	Rectangle	YCBN
Pad-51	Standard Table Pad	Pad-51

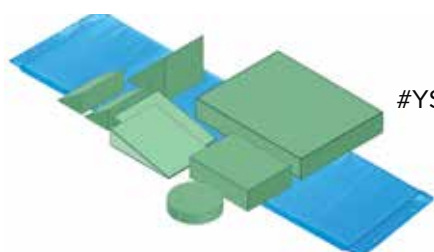

#YSGX

# General Sponge Kits

Overall dimensions: width X length X height.  
May be larger than traditional style.



#YKWA

**WEDGE KIT A**  
Uncoated OR Coated Kit includes:

uncoated	description	coated
YFBC	45° Wedge	YCBC
YFBF	27° Wedge	YCBF
YFBG	21° Wedge	YCBG
YFBI	(2) 15° Wedges	YCBI



#YSWA

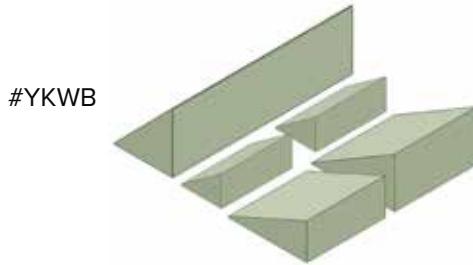

#YKWB

**WEDGE KIT B**  
Uncoated OR Coated Kit includes:

uncoated	description	coated
YFBD	45° Spine Wedge	YCBD
YFBE	(2) 34° Wedges	YCBE
YFBF	27° Wedge	YCBF
YFBG	21° Wedge	YCBG

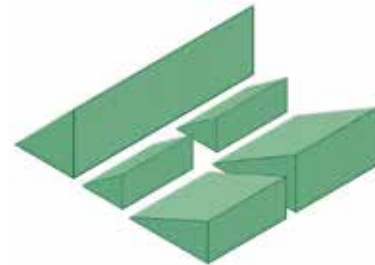

#YSWB



#YKRA

**RECTANGLE KIT**  
Uncoated OR Coated Kit includes:

uncoated	description	coated
YFBQ	(3) Rectangles	YCBQ
YFBR	(3) Rectangles	YCBR
YFBS	(3) Rectangles	YCBS
YFBT	(3) Rectangles	YCBT



#YSRA

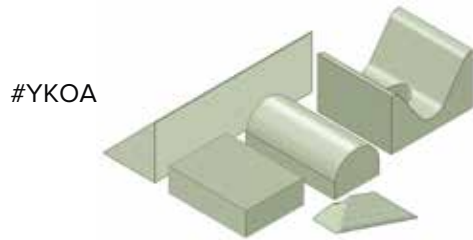

#YKOA

**ORTHO KIT A**  
Uncoated OR Coated Kit includes:

uncoated	description	coated
YFAA	Adult Obl Finger Block	YCAA
YFAM	AP/PA Adult Head Holder	YCAM
YFAR	Cervical Head Rest	YCAR
YFBD	45° Spine Wedge	YCBD
YFBL	Rectangle	YCBL

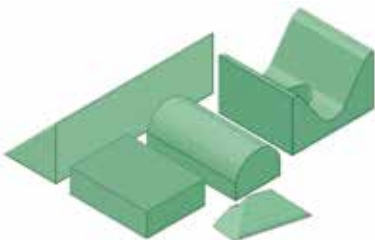

#YSOA

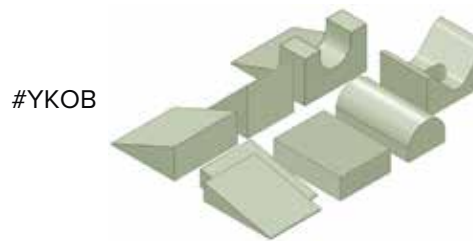

#YKOB

**ORTHO KIT B**  
Uncoated OR Coated Kit includes:

uncoated	description	coated
YFAL	Head & Neck Support	YCAL
YFAN	AP/PA Child Head Holder	YCAN
YFAR	Cervical Head Rest	YCAR
YFBC	45° Wedge	YCBC
YFBG	21° Wedge	YCBG
YFBJ	(2) 12° Wedges	YCBJ
YFBL	Rectangle	YCBL

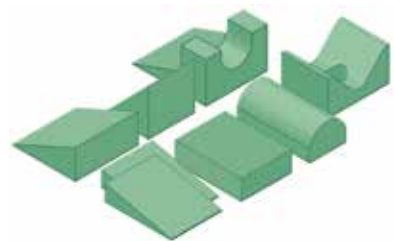

#YSOB

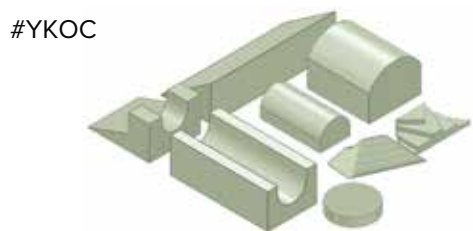

#YKOC

**ORTHO KIT C**  
Uncoated OR Coated Kit includes:

uncoated	description	coated
YFAA	Adult Obl Finger Block	YCAA
YFAD	Adult Lateral Finger Block	YCAD
YFAF	Leg Immobilizer	YCAF
YFAH	Knee Arthrogram Block	YCAH
YFAK	Circular Head Block	YCAK
YFAL	Head & Neck Support	YCAL
YFAR	Cervical Head Rest	YCAR
YFBU	Multi-Angle Wedge	YCBU

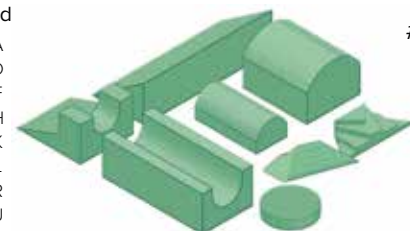

#YSOC

# Specialty Sponge Kits

Overall dimensions: width X length X height.  
May be larger than traditional style.



#YKCA



**CLINIC KIT A**  
Uncoated OR Coated Kit includes:

uncoated	description	coated
YFBB	45° Wedge	YCBB
YFAA	Adult Obl Finger Block	YCAA
YFAK	Circular Head Block	YCAK
YFBI	(2) 15° Wedges	YCBI

#YSCA



#YKCB

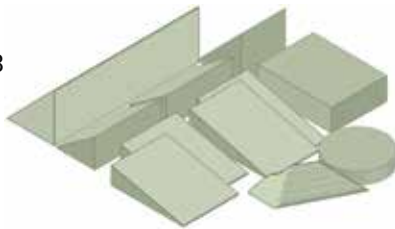

**CLINIC KIT B**  
Uncoated OR Coated Kit includes:

uncoated	description	coated
YFAA	Adult Obl Finger Block	YCAA
YFAK	Circular Head Block	YCAK
YFBC	45° Wedge	YCBC
YFBE	(2) 34° Wedges	YCBE
YFBI	(2) 15° Wedges	YCBI
YFBJ	(2) 12° Wedges	YCBJ
YFBL	Rectangle	YCBL
YFBD	45° Wedge	YCBD

#YSCB



#YKPA

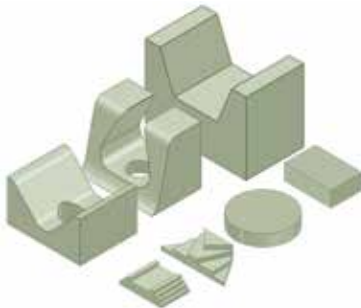

**PEDIATRIC KIT**  
Uncoated OR Coated Kit includes:

uncoated	description	coated
YFAC	Bilateral Child Obl Finger Block	YCAC
YFAE	Pediatric Lateral Finger Block	YCAE
YFAK	Circular Head Block	YCAK
YFAN	AP/PA Child Head Holder	YCAN
YFAQ	Child Head Immobilizer	YCAQ
YFAX	Child Myelogram Block	YCAX
YFBT	Rectangle	N/A

#YSPA



(YSPA does NOT include the rectangle shown in the YKPA.)

#YKBA

(YKBA uses the high-density bariatric foam as standard.)

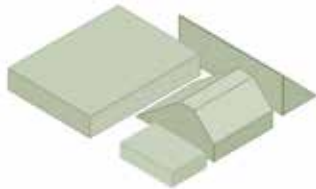

**BARIATRIC KIT**  
Uncoated OR Coated Kit includes:

uncoated	description	coated
YBAT	Torso Bolster	YCAT
YBBA	Spinal Wedge	YCBA
YBBM	Rectangle	YCBM
YBBP	Decubitus Pad	YCBP

#YSBA

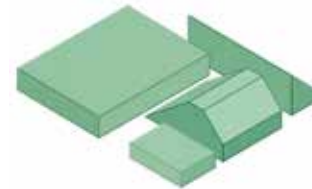

#YKTB



**TRAUMA KIT**  
Uncoated OR Coated Kit includes:

uncoated	description	coated
YFAH	Knee Arthrogram Block	YCAH
YFAP	Adult Head Immobilizer	YCAP
YFAY	Angular Bolster	YCAY
YFBB	45° Wedge (7x14x7)	YCBB
YFBH	(2) 16° Wedge (7x8x3.5)	YCBH
YFBL	Rectangle (7.5x10x3)	YCBL

#YSTB

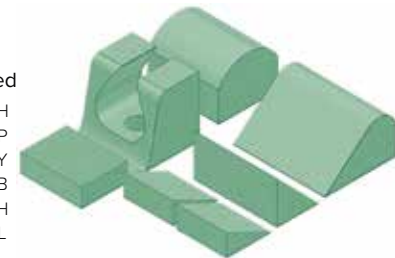

#YKHA



**HEAD & NECK KIT**  
Uncoated OR Coated Kit includes:

uncoated	description	coated
YFAK	Circular Head Block	YCAK
YFAL	Head & Neck Support	YCAL
YFAM	AP/PA Adult Head Holder	YCAM
YFAN	AP/PA Child Head Holder	YCAN
YFAP	Adult Head Immobilizer	YCAP
YFAQ	Child Head Immobilizer	YCAQ
YFAR	Cervical Head Rest	YCAR

#YSHA



# Coated-Only Specialty Sponge Kits

Overall dimensions: width X length X height.

## #YSCT

### CT IMAGING KIT 1

Coated Kit includes:

description	coated
45° Wedge	YCBB
45° Wedge	YCBC
(2) 34° Wedges	YCBE
27° Wedge	YCBF
21° Wedge	YCBG
(2) 15° Wedges	YCBI
(2) 12° Wedges	YCBJ
CT Headrest	YCBW



## #YSCT2

### CT IMAGING KIT 2

Coated Kit includes:

description	coated
CT Knee Wedge	YCAJ
Adult Head Immobilizer	YCAP
(2) 34° Wedges	YCBE
(2) 12° Wedges	YCBJ
CT Headrest	YCBW



## #YSCT3

### CT IMAGING KIT 3

Coated Kit includes:

description	coated
CT Knee Wedge	YCAJ
Adult Head Immobilizer	YCAP
CT/Cath Lab Headrest	YCET
Convertible CT Headrest	YCEV



## #YSCT4

### CT IMAGING KIT 4

Coated Kit includes:

description	coated
CT Knee Wedge	YCAJ
45° Wedge	YCBC
27° Wedge	YCBF
21° Wedge	YCBG
(2) 16° Wedges	YCBH
(2) 12° Wedges	YCBJ
45° Spinal Wedge	YCFD



## #YSRC

### ULTRASOUND KIT

Coated Kit includes:

description	coated
(10) Rectangles	YCBL

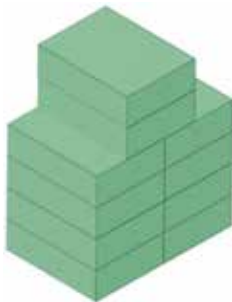

## #YSAS

### KNEE ARTHROPLASTY STRESS ASSEMBLY KIT

Coated Kit includes:

description	coated
45° Wedge (9x24x9)	
Contoured Cube (11x9x6)	

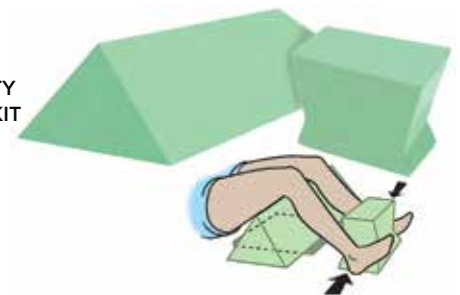

## #YSRD

### GENERAL / PERINEAL KIT

Coated Kit includes:

description	coated
Angular Bolster	YCAJ
45° Echocardiography Wedge	YCEE
Endo-Ultrasound Wedge	YCUZ



## #YSU8

### ULTRASOUND: BREAST OR PARACENTESIS

Coated Kit includes:

description	coated
21° Wedge	YCBG
30°-60°-90° Multi-Angle Wedge	YCBU
45° Spinal Wedge	YCFD





## Vinyl-Covered Bolster Blocks & Kits

Reusable blocks, bolsters, and wedges are manufactured from firm, high-density urethane foam. Royal Blue outer covering is durable, heavy gauge, reinforced vinyl. Seams are sewn and tear resistant. Easy to clean Bolsters are RADIOLUCENT, however, the seams may show. Provides excellent support for a wide variety of imaging needs.



#YVF45  
Cylinder  
26" x 6" dia.



#YVFA  
Cylinder  
24" x 8" dia.



#YVFB  
Semi-Round  
8" x 18" x 6"



#YVFJ  
Block  
8" x 12" x 3"



#YVFG  
Block  
8" x 12" x 6"



#YVFH  
Block  
12" x 14" x 3"



#YVFP  
Block  
18" x 24" x 4"



#YVFK  
Block  
20" x 13" x 3"



#YVFI  
Block  
24" x 15" x 3"



#YVF42  
Block  
12" x 12" x 9"

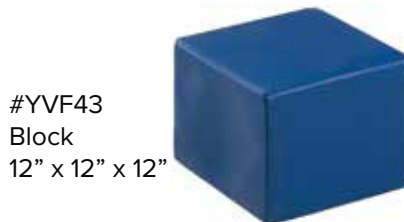

#YVF43  
Block  
12" x 12" x 12"



#YVFQ  
DEXA Block  
20" x 20" x 12"

## Bolster Kits



#YSU1  
KIT Includes:  
YVFB, (2) YVFG, YVFJ



#YSU2  
KIT Includes:  
YVFG, (2) YVFJ



#YSU3  
KIT Includes:  
YVFB, YVFD, YVFG

## Vinyl-Covered Bolsters Wedges & Kits



#YVFU  
30°/ 60°/ 90° Wedge  
10" x 24" x 6"



#YVFO  
45° Wedge  
7" x 21" x 7"



#YVFD  
45° Wedge  
8" x 16" x 8"

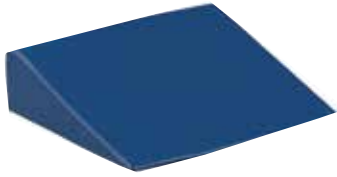

#YVFC  
20° Wedge  
24" x 18" x 6"



#YVDB  
30° CardiacWedge  
28" x 27" x 16"



#YVDA  
45° CardiacWedge  
28" x 14" x 14"

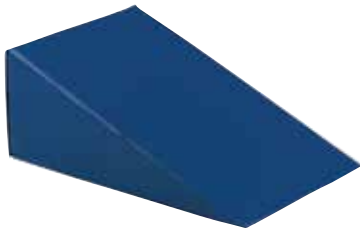

#YVFE  
20° Wedge  
20" x 32" x 12"

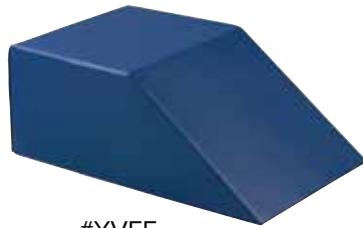

#YVFF  
50° Wedge  
20" x 32" x 12"



#YVF40  
26° Wedge/Knee  
13" x 17" x 6"

## Bolster Kits



#YSU4  
KIT Includes:  
YVFA, YVFB, YVFC, YVFD,  
YVFG, YV FH, YVFJ, YVFK



#YSU5  
KIT Includes:  
YVFB, YVFC, YVFD,  
YVFJ, YVFO



#YSU6  
KIT Includes:  
YVFJ, YVFK,  
YVFO, YV FV

# Vinyl-Covered Specialty Bolsters

Reusable bolsters are manufactured from firm, high-density urethane foam. Royal Blue outer covering is durable, heavy gauge, reinforced vinyl. Seams are sewn and tear resistant. Easy to clean Bolsters are **RADIOLUCENT**, however, the seams may show. Provides excellent support for a wide variety of imaging needs.



#YVFM  
Knee Bolster  
16" x 25" x 8.25"



#YVFZ  
Endo Ultrasound Wedge  
20" x 22" x 6"



#YVF41  
Stretcher/Wheelchair Bolster  
16" x 23" x 4.5"



#TBC-2214  
Lateral Decubitus Positioner Kit  
Pad: 20" x 13" x 3"



This KIT includes a 90° support with hook and loop stability straps and a YVFK decubitus bolster to aid in cross lateral examinations. The pad assures the patient is elevated into the imaging field.

#YVWS  
Curved Wheelchair Chest Bolster  
18" x 20" x 5"



The YVWS and the YVF41 (sold separately) are both designed to be perfect for chest x-ray positioning of wheelchair patients.



#TI-SET  
DEXA Positioning Kit  
KIT includes:  
(1) "A" Frame Foot Splint  
(1) YVFJ Head Bolster (8" x 12" x 3")  
(1) YVFQ Leg Bolster (20" x 20" x 12")



The large bolster aids in positioning the AP lumbar spine. The small head bolster and 15° "A" frame splint lock the feet into position to abduct both legs to hold full extension at the knees and hips.



## MRI Positioners

Unique visco-elastic material molds to patient's body shape and conforms to table platform. Meets specific requirements for MRI compatibility and safety with excellent radiolucent qualities. Antimicrobial cover with anti-slip undersurface - easy to clean and maintain.

*Additional MRI Positioners can be found on page 50.*

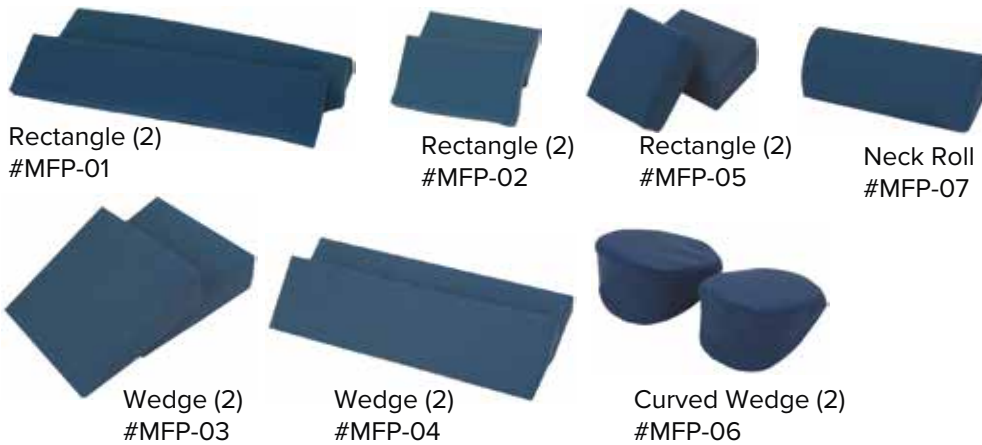

Knee Wedge #MFP-10



cat.#	w x l x d
MFP-01	14" x 3" x 1"
MFP-02	5" x 3" x 1"
MFP-03	10" x 10" x 3"
MFP-04	14" x 4" x 1.5"
MFP-05	3" x 4" x 2"
MFP-06	5.2" x 5.3" x 3"
MFP-07	3" x 7.3" x 2.3"
MFP-10	16" x 28.2" x 8"

*Highest Quality Solution for Patient Comfort and Safety for all MRI Exams!*



## MRI Table Pads

GE 1.5T & 3.0T

cat.#	w x l x d
MFP-20	15" x 13" x 0.625"
MFP-22	15" x 13" x 1.250"
MFP-24	15" x 27" x 1.250"

(MFP-24 is two pcs)

GE 0.2T, 0.35 & 0.7T

cat.#	w x l x d
MFP-30	29" x 14" x 0.625"
MFP-32	29" x 14" x 1.250"
MFP-34	29" x 28" x 1.250"

(MFP-34 is two pcs)

Hitachi

cat.#	w x l x d
MFP-40	31" x 13.5" x 0.625"
MFP-42	31" x 27.0" x 0.625"
MFP-44	27" x 13.5" x 0.625"
MFP-46	31" x 13.5" x 1.250"
MFP-48	31" x 27.0" x 1.250"

(MFP-42 & MFP-48 are two pcs)

Philips, Siemens, Toshiba

cat.#	w x l x d
MFP-50	19.5" x 14" x 0.625"
MFP-52	19.5" x 14" x 1.250"
MFP-54	19.5" x 28" x 1.250"

(MFP-54 is two pcs)

Other Positioners & Pads are available. Call for quote.

## MRI Positioner Pad Kits & Burn Pads



Burn Pads (4 kits available)



#MFP-BBK



#MFP-GNK

(Includes: MFP-01, MFP-02, MFP-03, MFP-04, MFP-05, MFP-06)



#MFP-GE2

cat.#	MRI Kit Description (# pieces)
MFP-GNK	General MRI Kit (12)
MFP-GE2	CTL Coil Pad Kit: GE 1.5T (2)
MFP-BBK	Breast Biopsy Positioning Kit (10)

Burn Pad Kits	
MFP-20P	MFP-20 Table Pads (2)
MFP-30P	MFP-30 Table Pads (2)
MFP-40P	MFP-40 Table Pads (2)
MFP-50P	MFP-50 Table Pads (2)

# GEL Patient Positioners

Radiolucent Gel Pads aid in pressure distribution without bottoming out. These pads are made of a solid, non-conductive, cross lined polymer that will not leak, ooze, or evaporate and is resistant to punctures and tears. Each antimicrobial, anti-bacterial pad is hypoallergenic, latex-free, silicone-free, and plasticizer-free, and will not harden over time. Following the instructions, the pads can be heated and cooled. Note: 0.25" thick gel is equivalent to .051mm Aluminum.

## FLAT PAD POSITIONERS

Protects skin from pressure sores and ulceration. Great for short term and long term situations.



cat. #	dimensions	wt	cat. #	dimensions	wt
YG-4008	12" x 4" x 1/4"	5	YG-7005	27" x 11" x 1/2"	8
YG-7002	11" x 17" x 1/4"	4	YG-1009*	20" x 20" x 1/2"	10
YG-8001*	17" x 11" x 1/4"	5	YG-1002*	39 1/2" x 20" x 1/2"	18
YG-7003	11" x 20" x 1/4"	5	YG-1008*	46" x 20" x 1/2"	20
YG-7000	9" x 11" x 3/8"	3	YG-1005*	72" x 20" x 1/2"	31
YG-8002*	11" x 9" x 3/8"	3	YG-8010*	21" x 18 1/2" x 5/8"	11
YG-1001	9" x 20" x 1/2"	5	YG-8014	11" x 9" x 1"	5
YG-8003*	26" x 12" x 1/2"	8	YG-8006	20" x 20" x 1"	18
YG-8005	17" x 11" x 1"	8	(*Excellent as Body & Support Surface Pads)		

## FLAT PAD w/ CUTOUT

cat. #	dimensions	wt
YG-1003	20" x 20" x 1/2"	8
YG-1007	46" x 20" x 1/2"	20

Same as above with cutout for greater access to patient and table/bed.



## LATERAL POSITIONER 29" x 19 1/2" x 6" x 1" #YG-3026

Stable and safe cradle for arm and upper body when positioned laterally.



## FLAT BOTTOM CHEST ROLLS

cat. #	dimensions	wt
YG-3004	12" x 4" x 4"	8
YG-3006	12" x 6" x 6"	15
YG-3008	16" x 4" x 4"	10
YG-3009	16" x 6" x 6"	20
YG-3010	20" x 4" x 4"	13
YG-3011	20" x 6" x 6"	25



Used for prone, lateral, and supine positioning. Protects chest and prevents rolling.

## HEEL-ELBOW PAD 3 1/4" x 1 1/2" dia. #YG-5025

Protects skin from pressure sores and ulceration in extended cases.



## TOBOGGAN ARM & LEG POSITIONERS

cat. #	description	dimensions	wt
YG-5030	arm pad only	7 3/4" x 6 1/4" x 3/8"	3
YG-5020	arm pad only	17" x 7 1/2" x 3/8"	4
YG-7020	leg pad only	17" x 7 1/2" x 3/8"	3
YG-5022	shield only	15 3/4" x 9 1/2" x 3/8"	5
YG-5021	arm pad & shield	15 3/4" x 9 1/2" x 3/8"	6
YG-7021	leg pad & shield	17" x 7 1/2" x 3/8"	5

Used with toboggan positioner to protect patients' arms and legs during OR procedures.



## TRAPEZOID POSITIONER 7" x 10" x 3" #YG-3035

Used for leg separation. Can be used as a knee stabilizer or under the feet to prevent foot drop.



## HEEL CUP-PROTECTOR #YG-4004

Helps relieve heel pressure in supine position. Provides for even distribution of weight on the foot and ankle.



## GEL Patient Positioners



Cradles and supports head and allows clear air passage.

### HORSESHOE OPEN HEAD RING

cat. #	description	dimensions	wt
YG-2007	adult	8" x 3" x 2"	4
YG-2009	pediatric	5½" x 2¼" x 1¼"	3
YG-2008	neonatal	3½" x 1½" x ¾"	2
YG-2012	bariatric	8" x 3" x 3"	5



Cradles head and protects the ear. Reduces pressure on occipital while supine.

### DONUT CLOSED HEAD RING

cat. #	description	dimensions	wt
YG-2000	adult	8" x 3" x 2"	4
YG-2004	pediatric	5½" x 2¼" x 1¼"	3
YG-2005	neonatal	3½" x 1½" x ¾"	2
YG-2015	bariatric	8" x 3" x 2"	5



### PRONE-SUPINE HEADREST

9" x 8" x 3"  
#YG-2010

Patient can rest comfortably even with respiratory tubes in place.



Unique center dish enhances patient comfort and protection.

### SUPINE HEAD PAD w/ CENTER DISH

cat. #	description	dimensions	wt
YG-2022	adult	10" x 9" x 2¼"	8
YG-2024	pediatric	7" x 6" x 2"	3
YG-2026	neonatal	5" x 4" x 2"	3



Conforming pad helps reduce pressure to side of patients' face and ear.

### LATERAL HEAD PAD w/ CENTER DISH

cat. #	description	dimensions	wt
YG-2023	adult	10" x 9" x 1"	6
YG-2025	pediatric	7" x 6" x 1"	3
YG-2027	neonatal	5" x 4" x 1"	3

### SIDE-SUPINE HEADREST

9" x 8" x 3"  
#YG-2021



Comfortable ear cutout for lateral position.



GEL ARMBOARDS relieve pressure on the hand, forearm, elbow and bicep. Ensures proper positioning and stability.

### FLAT ARMBOARD PADS

cat. #	size	dimensions	wt
YG-5000	small	15" x 4" x ¼"	3
YG-5005	large	25" x 5" x ¼"	3



### CONTOURED ARMBOARD PADS

cat. #	size	dimensions	wt
YG-5026	medium	16" x 6" x 2"	7
YG-5027	large	21" x 6" x 2"	9

### ULNAR & BRACHIAL NERVE PROTECTOR

18" x 13" x ¼"  
#YG-5011



### ULNAR & BRACHIAL NERVE PROTECTOR

15¾" x 6" x ½"  
#YG-5012



### AXILLARY ROLL COVER

17" x 12" x ½"  
#YG-3032



## GEL Sandbags

cat. #	dimensions	wt
YG-6000	6" x ½"	2
YG-6001	6" x 2"	2
YG-6002	8" x 1½"	2
YG-6003	10" x 1½"	3
YG-6004	12" x 1½"	5
YG-6008	10" x 4½" x 2"	5
YG-6010	12" x 4½" x 2"	4
YG-6011	14" x 5" x 2½"	5
YG-6012	16" x 12" x 1½"	12
YG-3015	10" x 4½" x 1½"	3
YG-3017	14" x 4½" x 1½"	5
YG-3025	14" x 9" x 2"	10

Extremely versatile positioners are soft on the surface, but firm inside where it counts. Each sandbag provides exceptional patient support as well as increased patient stability.



## Sandbags

All sandbags are filled with sand and are ready to use. Heat sealed inner sleeve prevents the leakage of sand. All seams are sewn and tear resistant. Deep green outer cover is heavy gauge, reinforced vinyl. Every sandbag includes a reinforced webbing handle.



**Custom Sizes Available!**

Includes weight ID tag



## Sandsocks

1-lb 2" x 8"  
#SBS-01



3-lb 4" x 12"  
#SBS-03



Includes weight ID tag



5-lb 5" x 15"  
#SBS-05



10-lb 6" x 20"  
#SBS-10



Sandsocks are loosely filled sandbags that contour to a broad range of shapes and forms. Stabilizes hard-to-hold and irregular anatomy. No need for additional person to hold the patient. Double seams for strength and longevity. Flexible, heavy gauge, reinforced vinyl. Only available in "honey" color.



12-lb 6" x 25"  
#SBS-12



10-lb 6" x 28"  
#SBS-28



15-lb 6" x 40"  
#SBS-40

**Sandbag Kits** (Save over ordering individually!)



5-lb cervical  
#SBK-CA  
Set: (2) 5-lb / 9" x 9"



10-lb cervical  
#SBK-CB  
Set: (2) 10-lb / 11" x 11"



20-lb cervical  
#SBK-CC  
Set: (2) 20-lb / 12" x 14"



10-lb AC Joint w/wrist grips  
#SBK-AC  
Set: (2) 10-lb / 11" x 11"



10-lb w/handles  
#SBK-HL  
Set: (2) 10-lb / 11" x 11"



femoral/angio  
#SBK-FB  
Set: (1) 5-lb / 5" x 12" (1) 7-lb / 6" x 14"  
(1) 10-lb / 7" x 16"



general set (a)  
#SBK-GA  
Set: (2) 3-lb / 5" x 9" (2) 10-lb / 11" x 11"  
(2) 7-lb / 6" x 14" (1) 5-lb / 7" x 9"  
(1) 5-lb / 5" x 12"



general set (b)  
#SBK-GB  
Set: (2) 3-lb / 5" x 9"  
(2) 7-lb / 6" x 14"  
(2) 10-lb / 11" x 11"



pediatric  
#SBK-PA  
Set: (1) 1-lb / 4" x 5" (1) 5-lb / 7" x 9"  
(1) 2-lb / 4" x 9" (1) 7-lb / 6" x 14"  
(1) 3-lb / 5" x 9"



sandsock kit  
#SBK-SA  
Set: (1) 1-lb / 2" x 8" (1) 12-lb / 6" x 25"  
(1) 10-lb / 6" x 20" (1) 5-lb / 5" x 15"  
(1) 3-lb / 4" x 12"



athletic/bariatric  
#SBK-AA  
Set: (2) 7-lb / 10" x 10"  
(2) 10-lb / 7" x 16"  
(2) 20-lb / 12" x 14"

**Mobile Sandbag Rack**

#SBM-100



Sandbags not included



Organize & store sandbags for easy retrieval. 2-sided panel with 20 hanging hooks. Base shelf on both sides. 3" swivel casters. 53"h x 25"w x 19"d.



## Standard Table Pads

Pads can be used for imaging tables or stretchers. Fabricated for durability and longevity. Helps maintain complete control of the patient. Affordable for each room and table. Three types of covering, depending on usage. Two brass eyelets in each end for hanging. Soft and comfortable. Cleans easy with mild cleaner or germicide.

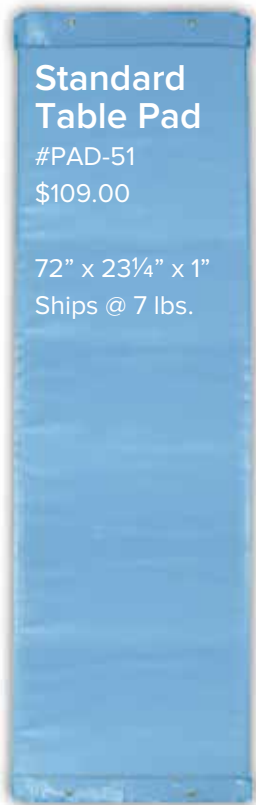

**Standard Table Pad**

#PAD-51  
\$109.00

72" x 23 1/4" x 1"  
Ships @ 7 lbs.

### TWO FOAM CHOICES:

- 1" comfort foam
- 2" firm density foam

### THREE COVER MATERIALS:

- Standard light blue vinyl (1 choice)
- Polyester-backed upholstery vinyl (6 choices)
- Nylon fabric (29 choices on page 25)



Light Blue (std vinyl)



Nylon (solid or print)



Green Upholstery



Red Upholstery



Black Upholstery



Blue Upholstery



Yellow Upholstery



Mint Upholstery

### Comfort Foam Pads

72" x 23 1/4" x 1"

cat.#	color	covering
PAD-51	Light Blue	Standard Vinyl
PAD-53	Green	Upholstery Vinyl
PAD-54	Red	Upholstery Vinyl
PAD-55	Black	Upholstery Vinyl
PAD-50	Blue	Upholstery Vinyl
PAD-52	Yellow	Upholstery Vinyl
PAD-56	Mint	Upholstery Vinyl
PAD-80	See Page 25	Nylon Fabric

(Edge of pads may show up on some images.)

### Firm Density Pads

72" x 23 1/4" x 2"

cat.#	color	covering
PAH-51	Light Blue	Standard Vinyl
PAH-53	Green	Upholstery Vinyl
PAH-54	Red	Upholstery Vinyl
PAH-55	Black	Upholstery Vinyl
PAH-50	Blue	Upholstery Vinyl
PAH-52	Yellow	Upholstery Vinyl
PAH-56	Mint	Upholstery Vinyl
PAH-80	See Page 25	Nylon Fabric

(Edge of pads may show up on some images.)

## Pad Storage Rack & Set

Two hooks on 12" centers.  
Mounts on 16" centers. Steel with white finish. Ships @ 4 lbs.

#PAD-R2 RACK ONLY

#PAD-S1 COMBO SET

(Combo Set includes: Standard Pad & Rack)



## Techno-Tuff™ Table Pads

Constructed of durable mesh laminate reinforced vinyl. 72" x 23" x 1" pad is radiolucent. Handles allow patients to be easily moved from stretcher to table. Low-friction, water proof, stain proof, and antimicrobial.

### TECHNO-TUFF™ PADS FEATURE:

#### TWO FOAM CHOICES:

- 1" comfort foam
- 2" firm density foam

### TECHNO-TUFF™ COVER MATERIAL:

Mesh laminate reinforced vinyl  
Colors: black or royal blue. With or without handles.

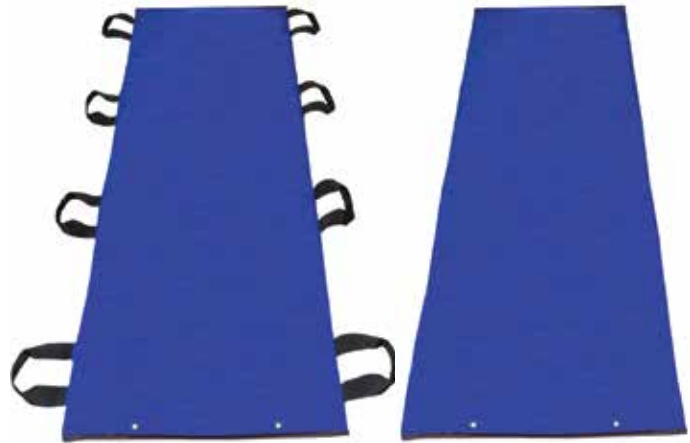

### Techno-Tuff™ Comfort Foam

72" x 23¼" x 1"

cat.#	color	description
PAD-H8R	Royal Blue	With Handles
PAD-H8K	Black	With Handles
PAD-X8R	Royal Blue	No Handles
PAD-X8K	Black	No Handles

### Techno-Tuff™ Firm Density

72" x 23¼" x 2"

cat.#	color	description
PAH-H8R	Royal Blue	With Handles
PAH-H8K	Black	With Handles
PAH-X8R	Royal Blue	No Handles
PAH-X8K	Black	No Handles

## Custom Pads

Rectangular pads made to your specs. Submit length" x width" x thickness".

Pads larger than 80"long x 30"wide x 2"thick may require further quote.

Custom Pads are NON-RETURNABLE.

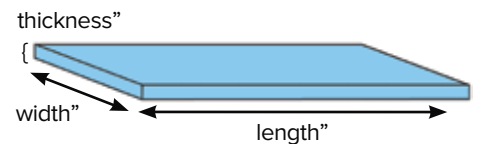

### Custom Comfort Foam

Up to: 80" x 30" x 2"

cat.#	color	covering
PAD-SP51	Light Blue	Standard Vinyl
PAD-SP53	Green	Upholstery Vinyl
PAD-SP54	Red	Upholstery Vinyl
PAD-SP55	Black	Upholstery Vinyl
PAD-SP50	Blue	Upholstery Vinyl
PAD-SP52	Yellow	Upholstery Vinyl
PAD-SP56	Mint	Upholstery Vinyl
PAD-SP80	See Page 25	Nylon Fabric

\*Sizes exceeding 80"x30"x2" in any direction call for quote.

### Custom Firm Density

Up to: 80" x 30" x 2"

cat.#	color	covering
PAH-SP51	Light Blue	Standard Vinyl
PAH-SP53	Green	Upholstery Vinyl
PAH-SP54	Red	Upholstery Vinyl
PAH-SP55	Black	Upholstery Vinyl
PAH-SP50	Blue	Upholstery Vinyl
PAH-SP52	Yellow	Upholstery Vinyl
PAH-SP56	Mint	Upholstery Vinyl
PAH-SP80	See Page 25	Nylon Fabric

\*Sizes exceeding 80"x30"x2" in any direction call for quote.

### Custom Techno-Tuff™ Comfort

Up to: 80" x 30" x 2"

cat.#	color	description
PAD-SPH8R	Royal Blue	With Handles
PAD-SPH8K	Black	With Handles
PAD-SPX8R	Royal Blue	No Handles
PAD-SPX8K	Black	No Handles

\*Sizes exceeding 80"x30"x2" in any direction call for quote.

### Custom Techno-Tuff™ Firm Density

Up to: 80" x 30" x 2"

cat.#	color	description
PAH-SPH8R	Royal Blue	With Handles
PAH-SPH8K	Black	With Handles
PAH-SPX8R	Royal Blue	No Handles
PAH-SPX8K	Black	No Handles

\*Sizes exceeding 80"x30"x2" in any direction call for quote.

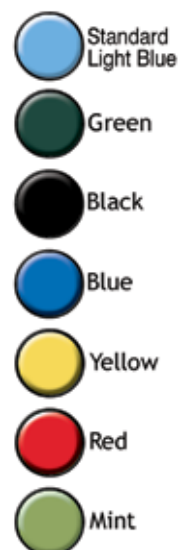

## Premium Table Pads

**NEW Premium Table Pads** offer excellent support and durability. Squared off corners are tailored to provide a nice, finished look that is perfect for any imaging table. Pads clean easily with mild cleaner or germicide.



Standard or Firm Density Foam Core

### 2" Premium Comfort Pad 72" x 23 1/4" x 2"

cat.#	color	covering
PPAD-55	Black	Upholstery Vinyl
PPAD-50	Blue	Upholstery Vinyl
PPAD-75	Black	4-Way Stretch

### Custom Premium Comfort Pad Up to: 80" x 30" x 2"

cat.#	color	covering
PPAD-SP55	Black	Upholstery Vinyl
PPAD-SP50	Blue	Upholstery Vinyl
PPAD-SP75	Black	4-Way Stretch



Squared Box Corner

### 2" Premium FIRM Density Pad 72" x 23 1/4" x 2"

cat.#	color	covering
PPAH-55	Black	Upholstery Vinyl
PPAH-50	Blue	Upholstery Vinyl
PPAH-75	Black	4-Way Stretch

### Custom Premium FIRM Density Pad Up to: 80" x 30" x 2"

cat.#	color	covering
PPAH-SP55	Black	Upholstery Vinyl
PPAH-SP50	Blue	Upholstery Vinyl
PPAH-SP75	Black	4-Way Stretch

**NEW Memory Foam Pads!** Constructed of a bottom layer of 1" standard foam and a top layer of 1" 5.5-lb Memory Foam to provide superior comfort for long procedures, recovery periods, or sensitive patients. Contouring support foam is radiolucent.



2-Ply Memory Foam

### 2" Premium MEMORY Pad 72" x 23 1/4" x 2"

cat.#	color	covering
PPAM-80	Black	4-Way Stretch

### Custom Premium MEMORY Pad Up to: 80" x 30" x 2"

cat.#	color	covering
PPAM-SP80	Black	4-Way Stretch



All Premium Table Pads are available with an optional **Anti-Slip Bottom Surface** that must be added to the same order as any of the above pads as: Cat. #PAD-ASB for an additional fee.

## Stretcher Replacement Pads

Economically priced replacement stretcher pads offer excellent support and durability. The black cover of 4-way-stretch antimicrobial fabric is tailored fitted over our firm 3" polyfoam. Squared off corners provide a nice, finished look with a resealable hook and loop end panel. Pads are CAL 117 compliant and clean easily with mild cleaner or germicide.



Ask us about Custom Pads with the standard four squared corners.



Also available: Custom Slant Corner Pad "A" For stretchers with hand holes at only one end.



Also available: Custom Slant Corner Pad "B" For stretchers with hand holes at both ends.

### 3" Standard Pad

cat. #	length x width
PMR-7224	72" x 24"
PMR-7226	72" x 26"
PMR-7228	72" x 28"
PMR-7230	72" x 30"
PMR-7424	74" x 24"
PMR-7426	74" x 26"
PMR-7428	74" x 28"
PMR-7430	74" x 30"
PMR-7624	76" x 24"
PMR-7626	76" x 26"
PMR-7628	76" x 28"
PMR-7630	76" x 30"

### 3" Pad w/ Anti-Slip Bottom

cat. #	length x width
PMR-7224ASB	72" x 24"
PMR-7226ASB	72" x 26"
PMR-7228ASB	72" x 28"
PMR-7230ASB	72" x 30"
PMR-7424ASB	74" x 24"
PMR-7426ASB	74" x 26"
PMR-7428ASB	74" x 28"
PMR-7430ASB	74" x 30"
PMR-7624ASB	76" x 24"
PMR-7626ASB	76" x 26"
PMR-7628ASB	76" x 28"
PMR-7630ASB	76" x 30"



## Specialty Premium Table Pads

Our collection of Specialty Premium Table Pads are designed to fit on specific manufacturers' imaging tables. Each pad offers excellent support and durability. The black cover of 4-way-stretch antimicrobial fabric is tailored fitted over our premium 2" comfort foam. Squared off corners and ends provide a nice, finished look that is perfect for any imaging table. Pads clean easily with mild cleaner or germicide. Custom size pads are also available.

All pads are shown in their proper proportions and to scale with each other.



#PPMS-ANS

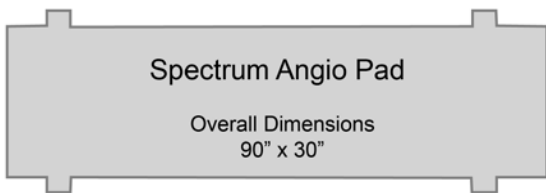

#PPMS-CYS

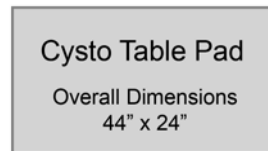

#PPMS-MEM

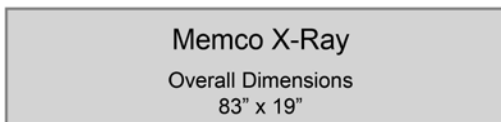

#PPMS-S50



#PPMS-XE8

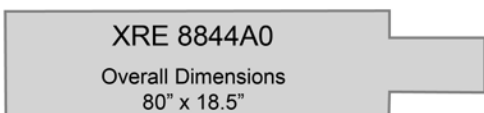

#PPMS-XEA

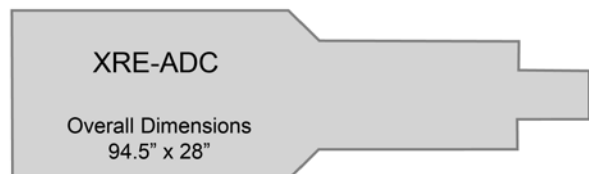

#PPGE-98R

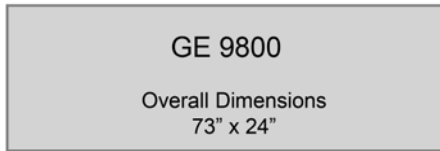

#PPGE-AFM



#PPGE-98N



#PPGE-ANG

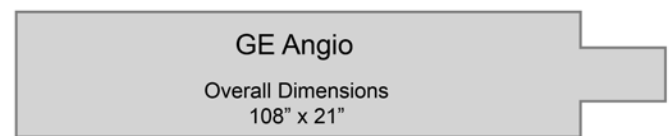

#PPGE-NRW

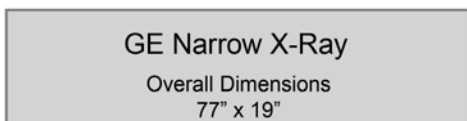

#PPGE-LUP

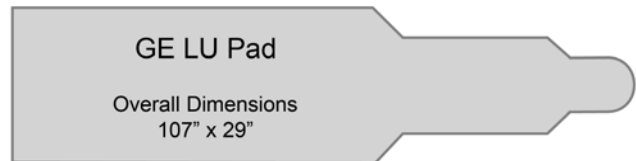

#PPGE-OM3

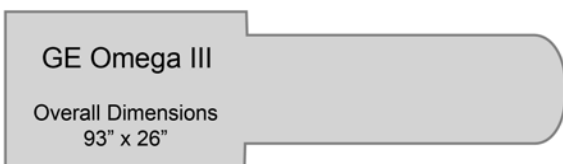

#PPGE-OM4

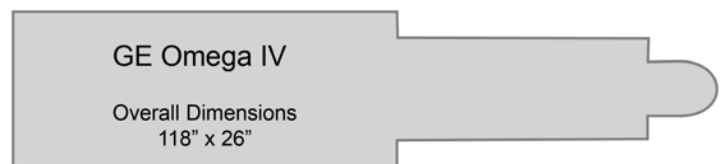

#PPGE-OM5



All pads are shown in their proper proportions and to scale with each other.

#PPSI-ANG

Siemens Angio Pad

Overall Dimensions  
66" x 21"

#PPSI-ANK

Siemens Koordinat Angio Table Pad

Overall Dimensions  
79" x 21"

#PPSI-CCL

Siemens CCL Cardiac Cath

Overall Dimensions  
79" x 23.5"

#PPSI-ECT

Siemens Orbiter ECT Special Procedure

Overall Dimensions  
78" x 18.5"

#PPSI-HIQ

Siemens HiQ

Overall Dimensions  
96" x 21"

#PPSI-SDR

Siemens Somatom DR

Overall Dimensions  
82" x 16"

#PPSI-HIS

Siemens HiQ Short

Overall Dimensions  
76" x 15"

#PPSI-SPL

Siemens Somatom Plus

Overall Dimensions  
75" x 16"

#PPSI-HIX

Siemens HiQ XL

Overall Dimensions  
114" x 15"

All pads are shown in their proper proportions and to scale with each other.

#PPTO-150

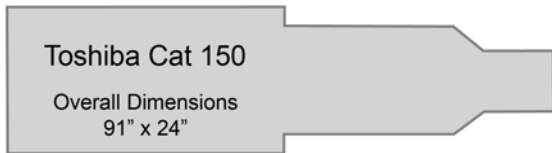

#PPTO-ANG

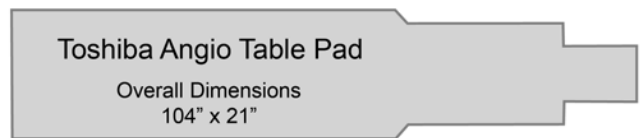

#PPTO-250

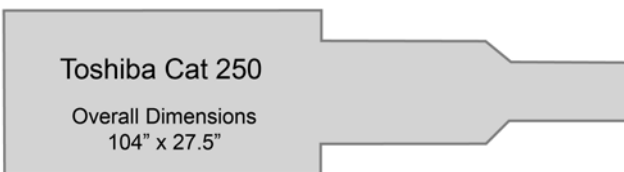

#PPTO-ANC



#PPTO-FX2



#PPTO-SCP

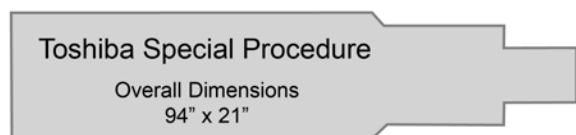

#PPPI-ANG

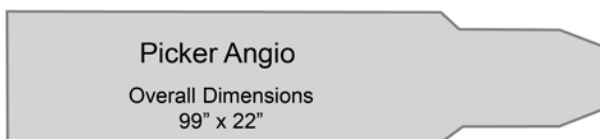

#PPPI-120

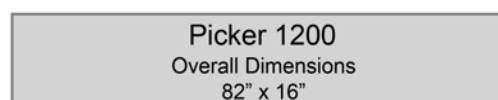

#PPPI-PCT



#PPPI-NXR

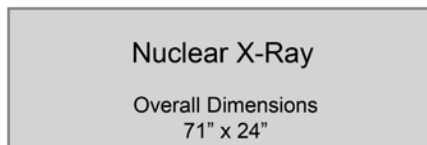



# Transfer Boards MR

Allows safe and efficient transfer of patients for general imaging, MRI, and CT. Durable, semi-rigid, slick material makes positioning under the patient easy. Transfer boards are radiolucent can be used in the imaging field. Conveniently located 1½" x 4½" hand-holds allow optimal movement. Regular Boards are made of ½" thick HDPE (high density polyethylene). Regular board color is white. Transfer boards ship at OverSize rates.

## REGULAR BOARDS

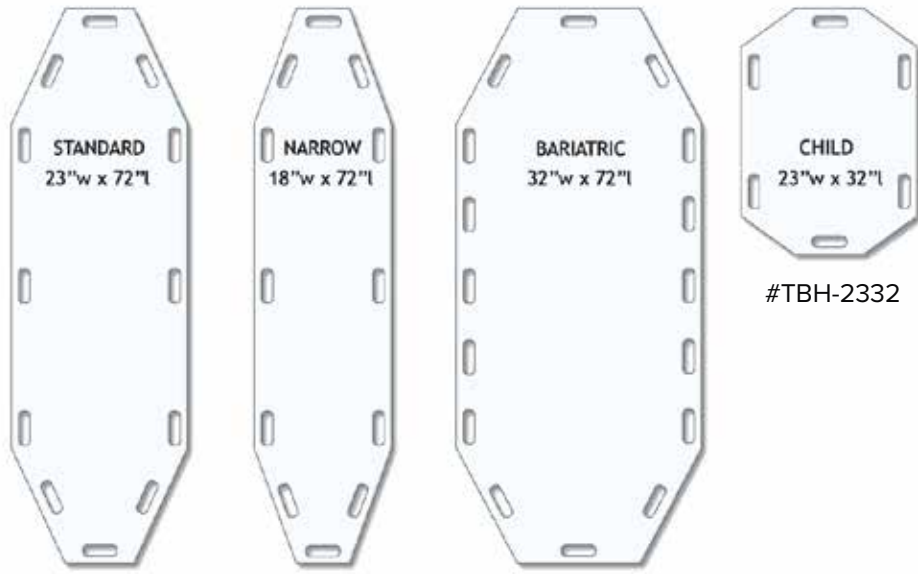

#TBS-2372	#TBN-1872	#TBB-3272
Qty 1-4:	Qty 1-4:	
Qty 5-9:	Qty 5-9:	
Qty 10+:	Qty 10+:	

## ANTI-STATIC BOARDS

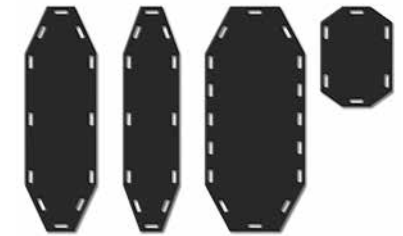

Anti-static boards are made of UHMW (ultra high molecular weight polyethylene). Anti-static boards are black. Standard, Narrow, and Bariatric boards ship at OverSize rates.

cat.#	description
TBS-2372AS	standard/half
TBN-1872AS	narrow
TBB-3272AS	bariatric
TBH-2332AS	half-size

## Engraved Transfer Option

Personalize your transfer boards for your facility. Each board can be engraved with your name, phone number, etc. to make sure your boards come back to YOU!  
(call for pricing)



## Board Wall Rack



#TBR-2P  
Two 6" pegs are angled to keep board from slipping. Mounting holes are on vertical centers. Steel with white enamel. Ships @ 4 lbs.



## Lifting Straps

#TBS-ST2  
ordered as a pair  
Convenient nylon straps loop through hand holds. Provides better grip. Provides extra length for better reach. Ships @ 1 lb.

## Restraint Straps



Super stong 2" nylon webbing. Secure snap buckle closure.

cat.#	girth	description
TBR-S72	72"	standard/half
TBR-N60	60"	narrow
TBR-B90	90"	bariatric

## Portable Blanket Warmer Bags



Holds 2-3 Blankets  
#BWS-03

Holds 4-5 Blankets  
#BWS-05

Holds 6-7 Blankets  
#BWS-07

All blanket warmer bags are IEC 60601-1 Medical Accessory Compliant.

Designed for radiology, surgery, outpatient, ER and EMS, these specially insulated blanket warmers keep warmed blankets warm. The durable and washable nylon exterior bag features a handy hook and loop closing flap. The removable interior heating elements keep the temperature at a steady 130° - 140°F when plugged into an optional, low voltage power supply (12vDC, <50w adapters sold separately). These lightweight and portable bags are designed and assembled in the USA and come with a 1-year warranty.

Optional AC Power Supply  
#BWS-ACS



Optional 12v Cord Adapter  
#BWS-12A



## Blanket Warmer Cabinets

Designed for radiology departments, interventional suites, ER and OR, mammography, ultrasound, CT outpatient clinics and surgery centers, these stainless steel blanket warmers are adjustable from 98° to 180°F (37° to 82°C) with the help of an intelligent 4-digit LED controller. With no moving parts and an audio-visual temperature alarm, these heavy duty units are designed for safety and built to last. All three units come with hospital grade power cords and the two larger units include locking casters. Operational at either 120VAC or 220VAC, all three units are UL & CSA approved.

### Countertop Unit

Holds 7 bed sized blankets.  
16" x 24" x 20"  
70 lbs.

#BW-210  
(call for price)

### Short Cabinet

Holds 25 bed sized blankets.  
22" x 29" x 40"  
170 lbs.

#BW-710  
(call for price)

### Tall Cabinet

Holds 50 bed sized blankets.  
22" x 29" x 70"  
350 lbs.

#BW-1400  
(call for price)



### Leg Support

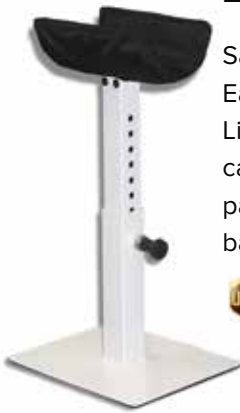

Safely supports and positions patient leg. Easy to use Posi-Lock height adjustment. Lift height range: 14½” to 19”. 6½” x 9½” calf support comes with nylon covered pad. All steel frame with sturdy 9” x 12” base. Shipping weight: 14 lbs.



#LGS-09

### Bariatric Leg Support



Same as LGS-09, except: Extra large 15” x 18” base. Shipping weight: 19 lbs.

#LGS-B11



Provides true 90° Lateral View of Hip. Unobstructed Femoral Head and Neck.

### Lateral Chest Support



Height adjustable bar provides stability for patients of almost every height. Helps reduce re-takes. Cast aluminum base easily mounts to the wall. Repositionable aluminum bar is comfortable to grip.

#RLC-36 (36” tall support)

#RLC-48 (48” tall support)

### Caliper

Accurately measures body thickness to be x-rayed, up to 21” in depth. Calibrated in both inches and cm. Made of durable aluminum. 1” wide x 21¼” tall x 10⅛” leg. Ships @ 1 lb.



#CAL-21



### Head Immobilizer

Safely supports and positions patient head. Solid steel angles with soft, vinyl covered cushions. Blocks with handles weigh 15-lbs each. Cushions: 8”w x 6”h x 3”d. Shipping weight: 32 lbs.

#RHI-AB

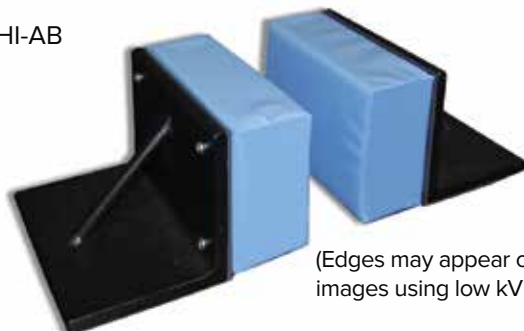

(Edges may appear on images using low kVp.)

### Head Paddles

Ideal for a designated person to keep patient’s head comfortable and steady. Rigid vinyl discs with comfort-grip handles. Coated foam cushions: 7”dia. x 1½”thick. Shipping weight: 4 lbs.

#RHI-CP



## Radiolucent Immobilizer Strap

Comfortably secures patient position and eliminates motion. Helps prevent patient falls without limiting respiration or circulation. Ideal for MRI, CT, and Radiology dept. Available in 3 widths and 5 length for a variety of patients and tables. Strap is heavy gauge reinforced vinyl. Fast and easy hook and loop closure. Easy to remove in case of emergency. Fast and easy hook and loop closure. Easy to remove in case of emergency.



BLUE is the default color.	<b>Available Colors</b>	cat.#	width x length
	 Blue (default)	RDH-060	7" x 60"
		RDH-072	7" x 72"
		RDH-084	7" x 84"
		RDH-096	7" x 96"
	 Black	RDH-120	7" x 120"
Colors are for Immobilizer Straps only.		RDP-060	14" x 60"
Hook and Loop is black.		RDP-072	14" x 72"
	 Green	RDP-084	14" x 84"
		RDP-096	14" x 96"
	 Yellow	RDP-120	14" x 120"
		RDW-060	20" x 60"
	 Red	RDW-072	20" x 72"
		RDW-084	20" x 84"
		RDW-096	20" x 96"
	 Mint	RDW-120	20" x 120"



## Universal Restraint

Universal clamp fits most imaging tables. 6" x 52" or 10" x 72" nylon strap firmly and comfortably holds the patient to the table with hook and loop closure. Brackets are stainless steel for long life.



#RDS-12 6" x 52"  
#RDS-22 10" x 72"

## Elastic Extremity Immobilizer

6" wide strap is designed for superior stability. Strap extensions then cross over patient where they are secured with "hook" and "loop" closure. Three standard lengths; custom available.



	width x length
cat.#	
RDF-084	6" x 84"
RDF-096	6" x 96"
RDF-120	6" x 120"

## Traction Straps

MANUAL #RDT-HN

Straightening the legs easily applies traction. Hook and loop hand-hold straps provide secure grip.



Hand-Hold Straps

*Lowers shoulders for cervical imaging.*

AUTOMATIC #RDT-SH

Primarily for elderly or unconscious patients. Rigid foot plate provides stable, steady support.



Buckle Straps

## Mammography Biopsy Chair

Ideal for use as a procedural chair or treatment table. The chair's versatility allows it to be used for pre-induction, transport, treatment, and recovery. Easy controls from either side of the chair allow height adjustment for optimal patient positioning. Seat height ranges from 23.5" to 31.5". Premium 5" Tente casters make for easy maneuvering. Backrest and leg section adjust from 90° upright to full spine, and 10° Trendelenburg. Features fold-down handrails and 3" comfort mattress. Weight capacity: 325 lbs.



#CRH-MBC  
(Call for Price)



## Video Fluoroscopic Chair

Ideal solution for radiology, mammography, and transport. Specially designed back has removable section to accommodate the space confinements of large imaging equipment. Easy controls allow height adjustment and full swivel for perfect patient positioning. Seat height range: 23.5" to 31.5". Premium 5" Tente casters make for easy maneuvering. Backrest and leg section adjust from 90° upright to full supine, and 10° Trendelenburg. Features a removable back section and 3" comfort mattress.



with seat rotated for increased imaging capacity.

# CRH-VIC  
(Call for Price)



## Defecogram Chair

Designed for use for patients with evacuation dysfunction. Defecography is a dynamic radiological examination that produces an anatomical depiction of the changes in the rectum and anal canal, and provides physicians with functional information about the movements of the pelvic floor at rest, during voluntary contraction, and with defecation. The chair allows radiography of a patient's bowel movement in radiology, rather than the more costly MRI/CT.

300-lb capacity unit includes locking casters, removable 10-qt basin, wrap around skirt for basin modesty, and a 9" raised heel support. Manufactured of Schedule 40 1¼" healthcare-grade PVC, this chair is non-returnable and offers a one-year warranty. Made in USA.

Cat.# CRH-DFC



## CT EZ-Positioner

Reduce distorted images from patient movement with this radiolucent positioner. Slide beneath the patient or strap it to the table in order to provide a platform with which the patient can comfortably use the hand-holds to keep their arms positioned over their heads for prolonged examinations.

The EZ-Positioner will not compromise IV lines and works well for patients undergoing needle biopsies and drainages.

5½" hand holds will accommodate most patient positions. The unit is 14" wide x 28" long.

Cat.# CT-EZ1

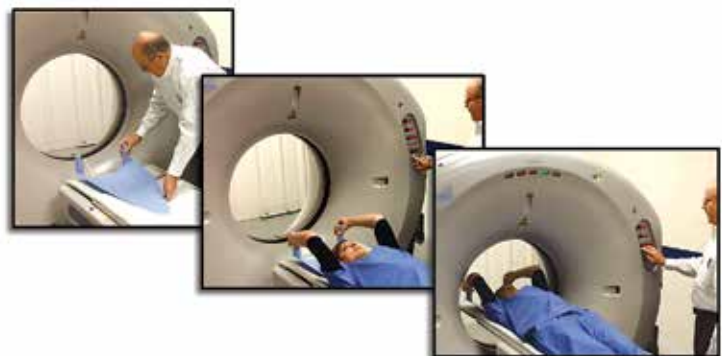

# Sterile Equipment Drapes

Take the guesswork out of selecting the correct sterile drape for your specific model C-Arm. Let us know which system you have and place your order. Our range of our drapes have been form-fitted for C-Arms to cover the image intensifier, x-ray tube, and flex arm, helping you eliminate the frustration and time of buying the wrong drape. Each drape is manufactured from 2 mil clear polyethylene and is latex-free. Each drape is designed to be durable and budget-friendly.



cat. #	description	qty
TA-4002	Elastic-end drape for Mini-C-arms: Officemate, Fluoroscope I and Fluoroscope III with 3/4" FOV	40
TA-4003	Elastic-end drape for Mini-C-arms: Fluoroscan Premier/Encore, Fluoroscan/Hologic Insight, Orthoscan, Lunar Orca, OEC with all FOV sizes, Xi Tex/Xi Scan	40
TA-8001	Open-end drape for: FluoroscanPremier/Encore, Fluoroscan/Hologic Insight, Orthoscan, Lunar Orca, OEC with all FOV sizes	40
TA-1001	Standard C-arm drape, 42" x 74" (compatible with full-size C-arms: OEC, Ziehm, Philips, Comed)	30
TA-1002	Consumable pack includes: C-arm drape, 24" x 20" footswitch cover, 36" x 36" image intensifier & x-ray tube cover, and 5 clips. Fits OEC 9600/9800/9900.	20
TA-1003B	Banded bag for 9" image intensifier, 30" x 30"	20
TA-1003D	Dome cover w/ latex-free elastic, 18" deep	20
TA-8004F	Foot switch cover, 24" x 20"	100
TA-8003F	Foot switch cover, 17" x 15"	100



## Mammography Exam Capes

Maintains patient modesty and confidence. Provides protection against cross-contamination. Comfortable, non-irritating materials. Eliminates laundry and replacement costs.



### White Cape

Open front/back. Soft 3-ply tissue. Size: 30" x 21". Color: WHITE. 100 capes per case.

#GMC-21

### Pink Cape

Open front/back. Soft 3-ply tissue. Size: 30" x 21". Color: PINK. 100 capes per case.

#GMC-22

## Standard Exam Gown

Open front/back w/ties. Soft tissue/poly/tissue. Regular size: 30" x 42" Color: BLUE. 50 gowns per case.

#GXE-55



## Extrasize Exam Gown

Open sides w/ties. Tissue/poly/tissue. Size: 40" x 50". Color: BLUE. 25 per case.

Size: XL  
#GXS-57



## Stretcher Sheets

Soft and water resistant. 2-ply tissue/poly. Size: 40" x 90". Color: WHITE/BLUE. 50 sheets per case.

#GSS-49



## Pillow Cases

Soft and water resistant. 2-ply tissue/poly. Size: 21" x 30". Color: BLUE. 100 cases per case.

#GPC-23





## True Wipes

A new standard for Lint-Free Wipes

Having passed the USP-797 clean environment testing, True-Wipes are ideal for lint-free cleaning of: CR/DR/CT/mammography screens, x-ray cassettes, work stations, PACS monitors, microscopes, lenses and general work surfaces. These highly absorbent 9" x 9" lint-free wipes can be used with screen cleaner, alcohol, bleach, and peroxide to clean and disinfect. Wipes are packaged in a resealable double bag to avoid contamination from typical box dispensers. Reinforces your vital QA standards.



#TW-200 (200 total wipes)



## SANI-CLOTH® AF3 Alcohol-Free Wipes

Contains an excellent range of effectiveness. Cleans, disinfects, deodorizes & fragrance-free. Alcohol content: ALCOHOL-FREE (less than 0.016%). Recommended Contact Time: 3-minutes or less. Commonly used for **MAMMOGRAPHY, ULTRASOUND and most other IMAGING EQUIPMENT**. PLUS daily use items like table pads, sandbags, coated sponges, transfer boards, aprons, shields, , vinyal straps... you name it. Meets CDC, OSHA and CMS Tag F441 guidelines.



cat.#	wipe size	quantity
GWP-WAF	6" x 6¾"	tub of 160 wipes
GWP-WAFCS	6" x 6¾"	case of 12 tubs

## Portable Medication Vial Holder

Shield your team from unintentional needle sticks associated with drawing up medication. Hand-held portable gripper protects the hands of individuals holding vials and provides a real-time safety checklist, while allowing the labels and expiration dates to be displayed without obstruction. Unique design allows product to securely and reliably hold varying sizes of vials.

#PMVH-01



# Radiation Badge Storage Boards

Provides a central location for all badge related activity. Exposure record display area and note clip. Accommodates different styles and sizes of badges. Ring board is also available for Nuclear Medicine and PET.



(badges available from your local provider)

**NARROW BADGES**  
less than 1" wide



#FB-10N



#FB-20N



#FB-40N

cat. #	style	badges	board size
FB-10N	narrow	10	12" x 5"
FB-20N	narrow	20	12" x 9.25"
FB-40N	narrow	40	12" x 18"
FB-10W	square/hex	10	12" x 9.25"
FB-20W	square/hex	20	12" x 18"
FB-40W*	square/hex	40	12" x 18"
FB-10R	ring(nuc.med.)	10	12" x 5"

\*(The FB-40W comes as two boards, each holding 20 badges.)

**SQUARE, HEX, WIDE, OBLONG BADGES**  
1" to 2" wide



#FB-10W



#FB-20W



#FB-40W

**RING BADGES**



#FB-10R

# Merrill's Pocket Guide to Radiography, 13th Edition

Quick reference, soft cover spiral. Ideal for the clinical setting. Step-by-step illustrations for positioning 200 of the most common projections. Unique digital radiography reference radiographs. Handy technique chart for every projection, with manual and AEC techniques. 4 3/8" x 7 1/4", ships @ 1 lb.

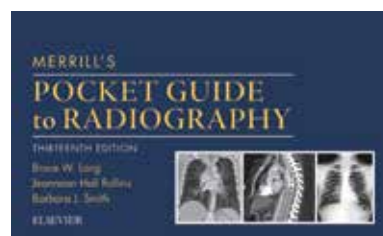

**Includes digital collimation sizes!**

#BK-MPGR



#1E  
R & L - 5/8"  
2 initials - 3/8" or 3 initials - 1/4"  
Without initials, order:  
#4E



#7E  
R & L - 1"  
2 initials - 3/8" or 3 initials - 1/4"  
Without initials, order:  
#5E



#2E  
RIGHT & LEFT - 1/2"  
2-3 initials - 1/4"  
Without initials, order:  
#122E



#6EB  
R & L - 1/2", arrow - 1"  
2-3 initials - 1/4"  
Without initials, order:  
#6EA

## Elite Style

Elite markers have the most DURABLE aluminum casing. RED for "R" markers and misc. words / BLUE for "L" markers. Provides the best in QC!

**REFERENCE:** Merrill's Atlas of Radiographic Positioning and Procedures, 9780323073219, text extract, "Each radiograph must include an appropriate marker that clearly identifies the patient's right (R) or Left (L) side. Medico-legal requirements mandate that these markers be present. R and L markers must be used with CR and DR digital imaging. The development of digital imaging and the use of CR and DR have enabled an environment in which the R and L markers can be placed on the image electronically. This is not recommended because of the great potential for error and legal implications. Anatomic markers should be placed on the CR cassette or DR table similar to screen-film cassettes."

**WORD and ARROW  
Markers are on page 98!**

**Personal Touch Markers  
are on pages 92-93!**

## Marker Mates

A new, reusable sticky strip that adheres markers to receptors or equipment. Simply peel off the protective film and apply to the back of your markers. Each pair of Marker Mates will last approximately 30-days under normal use and care. No more need for tape when you can instantly mate your markers!

#MM-XRAY  
1 pair

#MM-XRAY10  
10 pair

#MM-XRAY25  
25 pair

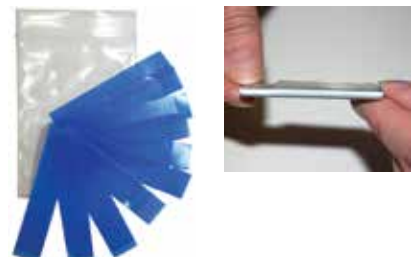

## Position Indicator Markers

Beads Indicate Patient Position



#TA-13  
Elite Style R & L - 5/8"  
2 initials - 3/8" or 3 initials - 1/4"  
Without initials, order:  
#TA-14t



#TA-1

R & L - 5/8"

2 initials - 3/8" or 3 initials - 1/4"

Without initials, order:

#TA-4

## Identifier Style

Identifier markers have high-impact polystyrene casing.

Enhances quality control with fewer repeat exams.

Provides basic, yet personalized image identification.

**WORD and ARROW**

**Markers are on page 98!**

**Personal Touch Markers**

**are on pages 92-93!**



#TA-7

R & L - 1"

2 initials - 3/8" or 3 initials - 1/4"

Without initials, order:

#TA-5



#TA-002

R & L - 5/8"

2 initials - 3/8" or 3 initials - 1/4"

Without initials, order:

#TA-001



#TA-2

Right & Left - 1/2"

2 or 3 initials - 1/4"

Without initials, order:

#TA-122

## Identifier Position Indicator Markers



#TA-17

Identifier Style R & L - 7/8" Position

2 initials - 3/8" or 3 initials - 1/4"



#TA-16

Identifier Style R & L - 7/8" Position

No initials

Personal Touch Colors & Shapes

*Who said work had to be boring?*



RED/BLUE SOLID

#TA-1

R & L - 5/8"

2 initials - 3/8" or 3 initials - 1/4"



RED/BLUE/PURPLE TIE-DYE

#PT-TR

R & L - 5/8"

2 initials - 3/8" or 3 initials - 1/4"



YELLOW SOLID

#PT-CY

R & L - 5/8"

2 initials - 3/8" or 3 initials - 1/4"



YELLOW/RED/ORANGE TIE-DYE

#PT-TY

R & L - 5/8"

2 initials - 3/8" or 3 initials - 1/4"



GREEN SOLID

#PT-CG

R & L - 5/8"

2 initials - 3/8" or 3 initials - 1/4"



ORANGE SOLID

#PT-CO

R & L - 5/8"

2 initials - 3/8" or 3 initials - 1/4"



BLUE/YELLOW/GREEN TIE-DYE

#PT-TB

R & L - 5/8"

2 initials - 3/8" or 3 initials - 1/4"



SKULLS  
#PT-SKW



TROPICAL FISH  
#PT-FRB

## Personal Touch Glitter

*Have fun in what you do!*



RED/BLUE GLITTER  
#PT-GR  
R & L - 5/8"  
2 initials - 3/8" or 3 initials - 1/4"



PURPLE GLITTER  
#PT-GP  
R & L - 5/8"  
2 initials - 3/8" or 3 initials - 1/4"



YELLOW GLITTER  
#PT-GY  
R & L - 5/8"  
2 initials - 3/8" or 3 initials - 1/4"



BURNT SIENNA GLITTER  
#PT-GS  
R & L - 5/8"  
2 initials - 3/8" or 3 initials - 1/4"



GREEN GLITTER  
#PT-GG  
R & L - 5/8"  
2 initials - 3/8" or 3 initials - 1/4"



ORANGE GLITTER  
#PT-GO  
R & L - 5/8"  
2 initials - 3/8" or 3 initials - 1/4"



PINK GLITTER  
#PT-GA  
R & L - 5/8"  
2 initials - 3/8" or 3 initials - 1/4"



LIGHT BLUE GLITTER  
#PT-GB  
R & L - 5/8"  
2 initials - 3/8" or 3 initials - 1/4"

# Image Scaling Marker Device

Scaling a digital image is mandatory in order to assure the highest level of diagnostic accuracy. It is critical to know the difference between the size of the anatomy shown on a digital monitor as compared to the actual anatomy. An easy to use, easy to clean, easy to understand calibration tool is a must, and a Rollr Precision Marker is the answer!



The patent pending radiolucent sphere holder and a size indicator sphere come together to allow perfect visibility of the sphere on the image as taken from any direction. A millimeter marker on the sphere holder indicates the size of the sphere that is being used.

The suction cup base allows the unit to be firmly secured to a flat table or a vertical wall bucky board that is close to the patient. The small footprint of the suction cup does not interfere with the patient, the technologist, nor limit its use.

The flexible gooseneck arm is perfect for positioning the calibration sphere as close as possible to the critical anatomy. The arm is covered with a smooth, crevice-free surface that allows for easy sanitation.

The autoclavable unit comes with the suction stand and one calibration sphere. Additional spheres can be bought separately in packs of six (6).

Full unit with 25mm sphere  
#A25DR

Full unit with 25.4mm (1-inch) sphere  
#A24DR

Full unit with 30mm sphere  
#A30DR



Replacement 25mm sphere (set of 6)  
#S25DR

Replacement 25.4mm sphere (set of 6)  
#S24DR

Replacement 30mm sphere (set of 6)  
#S30DR



Sphere easily slides in and out of socket.

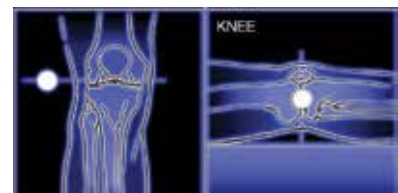
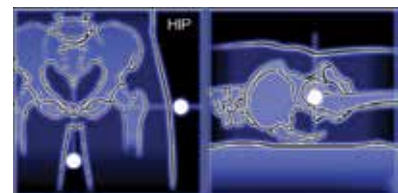

### CM Ruler Markers

The personalized R & L marker sets or the stand alone 3cm ruler are specifically designed for Teleradiology, CR and DR Imaging, where the image-size does not always match the life-size anatomy. Place a marker on the Receptor Plate and capture the radiographed anatomy. The image of the unique 3cm ruler gives an immediate visual and measureable cue as to the size of the screen image compared to the life size anatomy. Each marker has a lead 3cm ruler. Color coded: L-Blue, R-Red. High density lead characters.

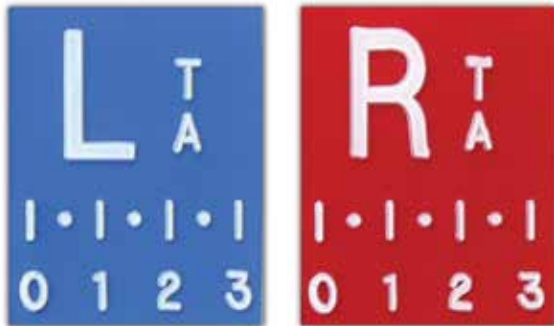

#1DR  
Ruler Style R & L - 3/4"  
2 or 3 initials - 1/4"



#3DR  
Ruler only

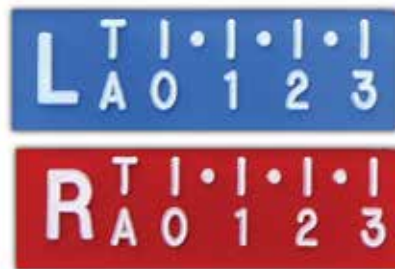

#2DR  
Ruler Style R & L - 1/2"  
2 or 3 initials - 1/4"

### Wafer-Thin Digital Imaging Markers

Perfect for equipment (CR, DR, etc.) with very thin bucky clearance. Exceptionally thin markers: <math>\lt; 3/32\text{''}</math> (2mm). Copper filtered for a broad range of KV. Elite style and color-coded.

*Super Thin for Slim Bucky Clearance*

*Other Wafer-Thin markers are on pages 96 & 98!*



#WTS-DR  
Ruler Style R & L with 3cm spacing

### Radi-O-Paque Extremity Rulers

Sturdy 1/4" wide x 1/8" thick. High density lead letters. Brilliant YELLOW color. Spaced in 0.5cm increments.

45cm  
#CPT-R45



115cm  
#CPT-R115



Enlarged View

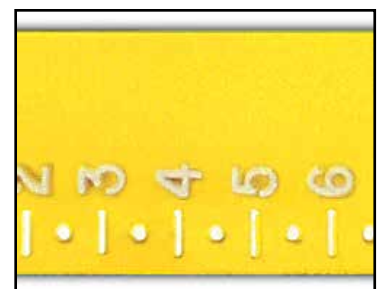



## Wafer Thin

### Super Thin for Slim Bucky Clearance

Perfect for newer equipment (CR, DR, etc.) with very thin bucky clearance. Exceptionally thin markers:  $< \frac{3}{32}$ " (2mm). Copper filtered for a broad range of KV. Elite style and color-coded.



#WTS-6B

R & L -  $\frac{3}{8}$ " 2 initials -  $\frac{3}{16}$ "

Without initials (with arrow), order:  
#WTS-6A



#WTS-6C

R & L -  $\frac{3}{8}$ " 2 initials -  $\frac{3}{16}$ "

Without initials, order:  
#WTS-6D



#WTS-1

R & L -  $\frac{3}{8}$ " 2 initials -  $\frac{3}{16}$ "

Without initials, order:  
#WTS-4 @ \$21.00/set



(See Wafer Thin Words on p.98)



#WTW-A3 ( $\frac{1}{2}$ " arrow)

## Oncology, CT and CR

### Super Thick for High Radiation

$\frac{1}{4}$ " super thick, high-density lead letters. Designed for Oncology and Industry, and other applications. Elite style markers, color-coded and Techno-Aide tough.

*The Oncology markers are  $\frac{1}{4}$ " thick and will NOT fit in most low clearance bucky trays.*



#RO-107B

R & L -  $\frac{3}{4}$ " 2 initials -  $\frac{3}{8}$ "

Without initials, order:  
#RO-107A

Vinyl & Epoxy encased, for longer life!



Ex.: ROW-23  $\frac{3}{4}$ " letters ( $\frac{1}{4}$ " thick)

cat.# (3/4")	description
ROW-01	single letter
ROW-23	2-3 letters
ROW-45	4-5 letters
ROW-67	6-7 letters
ROW-80	8+ letters

## Copper Filtered

Copper filtered for High KV. High density lead letters. Available in ELITE or IDENTIFIER. Color-coded, impact resistant. (Should not be used for mammography.)

*Filtered for High KV Exams*



#COP-1 ELITE

(2 sets of 1E markers: 1 set with copper filter, 1 set without.)



#COP-2 ELITE

R & L -  $\frac{1}{2}$ ", 2-3 initials -  $\frac{1}{4}$ "

(Filtered & unfiltered on the same marker.)

## Standard Thin Clipper

Constructed of high strength Kydex™. Extra thin profile, double-sided, 1 7/8" wide. R and L: 3/4", with or without initials. 2 Initials: 3/8"; 3 initials or words: 1/4".

#CPP-40  
(with initials)

#CPP-42  
(no initials)



Side View



## Stencil Clipper

Plated Steel Clipper

#XSCP-10  
Stenciled non-personalized R & L.



## Gridcap Thin Clipper

Designed to fit DR, CR receptors with gridcap. Constructed of high strength Kydex™. Extra thin profile, double-sided, 1 7/8" wide. R and L: 3/4", with or without initials. 2 Initials: 3/8"; 3 initials: 1/4".

#CPP-60 (with initials)

#CPP-61 (no initials)



## Elite Clippers

Both R & L are on one double clip. Durable Stainless Steel clips. Color-coded: R side-Red / L side-Blue.

Double Personalized



#CP-35  
(2-3 initials)

Portable & Position Double Clippers



#CP-36  
(with initials)

#CP-37  
(no initials)



#CP-13  
(with initials)

#CP-14  
(no initials)

## ELITE Words (aluminum casing)



Personalized  
Marker Sets  
are on  
pages 90-93

description	example	cat.# (3/8")	price	cat.# (1/2")
single letter	3	2E-Y	\$9.00	2E-Z
2-3 letters	EXT	3E-Y	\$11.00	3E-Z
4-5 letters	25 MIN	4E-Y	\$13.00	4E-Z
6-7 letters	STRESS	5E-Y	\$15.00	5E-Z
8+ letters	PORTABLE	6E-Y	\$18.00	6E-Z

## IDENTIFIER Words (polystyrene casing)

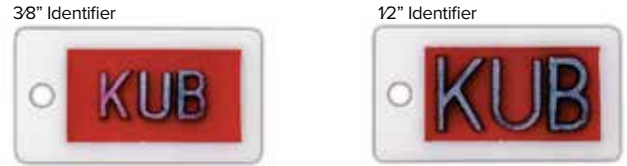

description	example	cat.# (3/8")	price	cat.# (1/2")
single letter	3	2TA-Y	\$8.00	2TA-Z
2-3 letters	EXT	3TA-Y	\$10.00	3TA-Z
4-5 letters	25 MIN	4TA-Y	\$12.00	4TA-Z
6-7 letters	STRESS	5TA-Y	\$14.00	5TA-Z
8-15/8-10	PORTABLE	6TA-Y	\$17.00	6TA-Z

## WAFER THIN Words

(14" letters x <math>\frac{3}{32}</math>"thin)



cat.# (3/4")	description
WTW-01	single letter
WTW-23	2-3 letters
WTW-45	4-5 letters
WTW-67	6-7 letters
WTW-80	8+ letters

## ONCOLOGY Words

(3/4" letters x 1/4" thick)



cat.# (3/4")	description
ROW-01	single letter
ROW-23	2-3 letters
ROW-45	4-5 letters
ROW-67	6-7 letters
ROW-80	8+ letters

## Wall Boards

Walnut grain w/brass hooks.



cat.#	description
HK-32	32 Hook Board
HK-16	16 Hook Board
HK-8	8 Hook Board
HK-50	50 Hook Board

These are just a few suggestions from all possible word choices:

2-3 letters	4-5 letters	6-7 letters	8+ letters
AP	FLAT	AP ERECT	ANTERIOR
PA	FLEX	CLOSED	EXTENSION
ANT	INSP	INT ROT	INFUSION
EXP	LEFT	MOBILE	PORTABLE
EXT	OPEN	P EVAC	POST EVAC
INT	POST	POST OP	POST VOID
KUB	TOMO	RECUMB	STANDING
LAO	DECUB	STRESS	VERTICAL W/WEIGHT
LPO	ERECT	SUPINE	WEIGHT BEARING
MAG	HOURS	DELAYED	INJECTION
MIN	PRE OP	FLEXION	INVERSION
OBL	PRONE	LATERAL	SEMI ERECT
RAO	PUREE	MINUTES	VALSALVAR
LOA	RIGHT	OBLIQUE	WT BEARING
25	SCOUT	SUNRISE	COMPARISON
600	60 MIN	UPRIGHT	DECUBITUS

## General Marker Set



Identifier Set shown (Board: 12" x 15")  
3/8" letters / 1/2" numbers

Elite	Identifier
#GME-60	#GMI-65



#A-3  
Arrow - 1" Elite Style



#TA-A3  
Arrow - 1" Identifier Style



250 Stickers  
per box



## Cover Tab Stickers

Ideal for coding mismarked or unmarked film. Color coded: L-Blue / R-Red. Self-adhesive backing. 1¼" diameter with square for initials. Available in greater quantity discounts!

**Take Advantage of  
Quantity Discounts!**

cat.# (¾") 1-3 boxes 4-9 boxes 10+ boxes

TAB-R

TAB-L

## Marking Pens

Highlights points of interest on a film. Wax markers resist smudging, but are not permanent. NOT to be used in place of lead markers. NOT a legally acceptable marking method.

**Order each item per number of packs.**

Example: 2ea. #MPY-11

(will be shipped with 10 yellow pens.)



Example of the  
MPA-19  
Assorted Pack



PENS (5 per pack)

cat.# (¾")	color
MPY-11	Yellow
MPR-12	Red
MPW-13	White
MPA-19	2-Y, 2-R, 1-W

REFILLS (72 per pack)

cat.# (¾")	color
MPY-21	Yellow
MPR-22	Red
MPW-23	White

Refills come in pkgs of 72 pieces.



**CHOOSE YOUR  
OWN COLOR!**

**A tool pouch for your markers!**



## Marker Keeper

Convenient four-pouch vinyl holder for markers. Handy clip attaches the Marker Keeper to belt, lapel, pocket, etc. Keeps markers in easy reach for quick retrieval.

cat.# (¾") color

MKR-11	Red
MKB-12	True Blue
MKG-13	Green
MKY-14	Yellow
MKC-15	Clear
MKA-19	*Assorted (4)

(\*Assorted set does NOT include Clear.)

## Skin Markers for General X-Ray, Mammography, CT and Oncology

GENERAL IMAGING: used to identify areas of pain or trauma, soft tissue masses, to document points of entry and exit sites, or mark prominent nipples for identification of nipple shadows on chest x-rays.

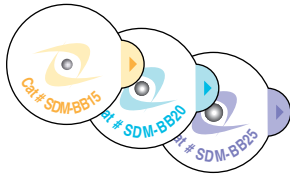
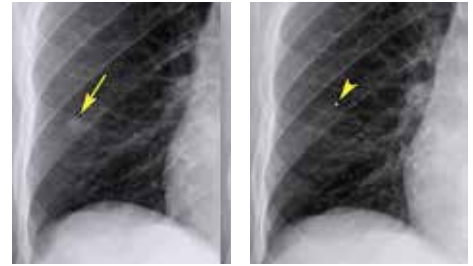

### Skin Dots

Artifact/nipple identifier. Helps eliminate repeat exams. Lead-free. Easy-Peel tab.

cat.#	BB size
SDM-BB15	1.5mm
SDM-BB20	2.0mm
SDM-BB25	2.5mm
1-5 bxs	6-14 bxs 15+ bxs
(100 per box)	



### Skin Wings

Artifact/nipple identifier. Extra support for larger, more prominent nipples. Lead-free. Easy-Peel tab.

cat.#	BB size
SDM-W15	1.5mm
SDM-W20	2.0mm
SDM-W25	2.5mm
1-5 bxs	6-14 bxs 15+ bxs
(100 per box)	



### Skin Strip

Lead-free nipple identifier. Ideal for larger, more prominent nipples. Adhesive-free nipple zone.

cat.#	BB size
SDM-NS25	2.5mm
1-5 bxs	6-14 bxs 15+ bxs
(100 per box)	

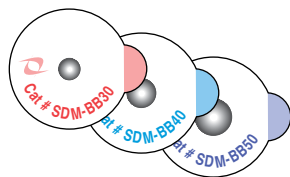

### Skin Dots (Rad/Onc)

Lead-free artifact identifier. Larger BBs for Radiology and Oncology. Easy-Peel tab.

cat.#	BB size
SDM-BB30	3.0mm
SDM-BB40	4.0mm
SDM-BB50	5.0mm
1-5 bxs	6-14 bxs 15+ bxs
(50 per box)	



### Skin Arrow (Rad/Onc)

Lead-free arrow pointer. Highlights areas of interest for Radiology and Oncology. Easy-Peel tab.

cat.#	BB size
SDM-A1	7.0mm
1-5 bxs	6-14 bxs 15+ bxs
(100 per box)	

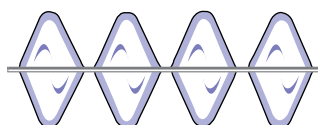

### Skin Line/Scar Marker

Lead-free scar identifier. Line contours to complex scar tissue. Flexible adhesive tabs; no scissors required.

cat.#	BB size
SDW-SS3	1.0mm
1-5 bxs	6-14 bxs 15+ bxs
(120*/305cm per box)	



Easy-Peel, adhesive-free tabs allow comfortable removal of the marker.

## Digital Mammography Skin Markers



### Digital Dot

Lead-free nipple identifier. Highlights areas of interest for digital and analog imaging. Easy-Peel tab.

cat.#	BB size
SDM-BB23	2.3mm
1-5 bxs	6-14 bxs 15+ bxs
(100 per box)	



### Digital Strip

Lead-free nipple identifier. Ideal for larger, more prominent nipples. Adhesive-free nipple zone.

cat.#	BB size
SDM-NS23	2.3mm
1-5 bxs	6-14 bxs 15+ bxs
(100 per box)	

## CT Skin Markers



### CT Dot: 2.3mm

Lead-free 2.3mm marker. Highlights areas of interest for Radiology and CT. Easy-Peel tab.

cat.#	BB size
SDM-CT1	2.3mm
1-5 bxs	6-14 bxs 15+ bxs
(50 per box)	



### CT Dot: 4.0mm

Lead-free 4.0mm marker. Highlights areas of interest for Radiology and CT. Easy-Peel tab.

cat.#	BB size
SDM-CT2	4.0mm
1-5 bxs	6-14 bxs 15+ bxs
(50 per box)	

## Multi-Modality Skin Markers



### Nuclear Med /PET

2mm center hole suitable for injection of radioisotope. Highlights areas of interest for Nuc. Med., PET, CT and MRI.

cat.#	BB size
MM3003	5.0mm
1-5 bxs	6-14 bxs 15+ bxs
(50 per box)	



### Therapy / Radiology

2mm center hole suitable for conventional hypodermic needle. Highlights areas of interest for Oncology and Radiology.

cat.#	BB size
MM3005	5.0mm
1-5 bxs	6-14 bxs 15+ bxs
(50 per box)	



### CT / MRI

No center hole; appears as bright object on CT and MRI scans. Also highlights areas of interest for radiology and mammography.

cat.#	BB size
MM3007	solid, no hole
1-5 bxs	6-14 bxs 15+ bxs
(50 per box)	

## Economy Nipple-Artifact Markers

Encapsulated 2mm lead ball. Used to mark nipple, lesion, scar, artifact, etc. Neutral color, peel-off, self-adhesive backing. Non-sterile. 100 markers mounted on ten convenient strips. (This product contains lead.)

#LNA-20



## Lead Characters

If you have any questions about the size characters you need or are looking for additional sizes and styles, please call our customer service department, or mail us a sample so that we may send you exactly what you're looking for.



### UNmounted Lead Characters

style	(3/16")	(1/4")	(3/8")	(1/2")	(5/8")	(1" R&L only)	(1" arrow)
FLAT FACE	XTUF-36	XTUF-14	XTUF-38	XTUF-12	XTUF-58	XTUF-01	X
DEEP BLOCK	X	XTUB-14	XTUB-38	XTUB-12	(see Flat Face)	X	X
ARROWS	X	XTUA-14	X	XTUA-12	X	X	XTUA-01

Flat Face | Deep Block | Arrow



"Loose" lead letters & numbers.

### Individual Mounted Characters (Flat Face)

cat.#	lead/plastic size	comments
XTSF-3658	3/16" on 5/8"	Fits: LLH-58, LLH-2, LLH-3, Veri-Thin
XTSF-3634	3/16" on 3/4"	Fits: Legal (regular)
XTSF-1458	1/4" on 5/8"	
XTSF-1434	1/4" on 3/4"	
XTSF-1478	1/4" on 7/8"	Fits: Eclipse, Perfection
XTSF-1234	1/2" on 3/4"	
XTIF-3658	3/16" on 5/8"	Fits: Ideal (special offset mounting)



Characters are mounted on CLEAR flat plastic tabs to fit a variety of letter holders.

### Flat Surface Mounted Words (Flat Face)

description	example	cat.#	cat.#	cat.#	cat.#
single letter	3	XVFW-0136	XVFW-0114	XVFW-0112	XVFW-0101
2-3 letters	EXT	XVFW-2336	XVFW-2314	XVFW-2312	XVFW-2301
4-5 letters	25 MIN	XVFW-4536	XVFW-4514	XVFW-4512	XVFW-4501
6-7 letters	STRESS	XVFW-6736	XVFW-6714	XVFW-6712	XVFW-6701
8+ letters	PORTABLE	XVFW-8036	XVFW-8014	XVFW-8012	XVFW-8001
Lead/Plastic Sizes		3/16" on 3/4"	1/4" on 3/4"	1/2" on 3/4"	1" on 1 1/2"



Words made from Mounted Letters glued to the surface of a single CLEAR vinyl strip.

## Lead Letter Case

Injection Molded Box. 36 scoop-bottom compartments (for A-Z and 0-9). Side compartment for holder.

#XSLC-36



# MARKERS

lead letter holders / sets

## Ideal Cushion Marker

Double channel with cushions; imprint in the upper section of each channel.

#XSIC-21

Holder only. 3½" x 15/16"

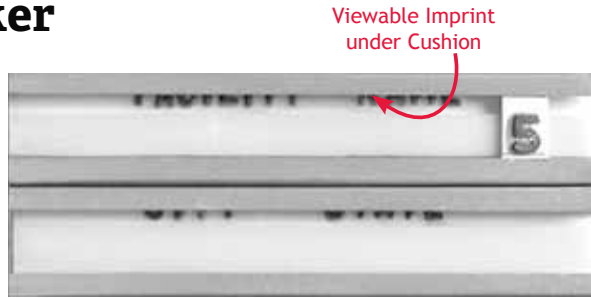

#XSIC-22

Complete Set Includes:  
1ea. holder  
2ea. A-Z  
4ea. 0-9  
2ea. A, E, I, O, U  
1ea. 36-letter case  
(Replacement characters:  
3/16" on 5/8" plastic tabs, offset.  
Reorder #XTIF-3658)

## Eclipse Cushion Marker

Single channel with cushion; imprint above and below the centerline.

#XSEC-11

Holder only. 3½" x 15/16"

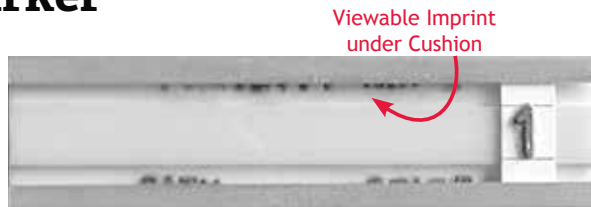

#XSEC-12

Complete Set Includes:  
1ea. holder  
2ea. R, L  
4ea. 0-9  
1ea. 36-letter case  
(Replacement characters:  
1/4" on 7/8" plastic tabs.  
Reorder #XTSF-1478)

## Legal Marker

Double aluminum channels; imprint between the two channels.

#XSLG-21

Holder only. 3½" x 15/8"



#XSLG-22

Complete Set Includes:  
1ea. holder  
2ea. A-Z  
4ea. 0-9  
2ea. A, E, I, O, U  
1ea. 36-letter case  
(Replacement characters:  
3/16" on 3/4" plastic tabs;  
Reorder #XTSF-3634)

## Veri-Thin Legal

Double aluminum channels; imprint down and in between the two channels. Great for Bucky Trays!

#XSVL-21

Holder only. 3½" x 113/16"



#XSVL-22

Complete Set Includes:  
1ea. holder  
2ea. A-Z  
4ea. 0-9  
2ea. A, E, I, O, U  
1ea. 36-letter case  
(Replacement characters:  
3/16" on 5/8" plastic tabs.  
Reorder #XTSF-3658)

## Perfection

Single aluminum channel; imprint above and below the channel.

#XSPF-11

Holder only. 3½" x 15/16"



#XSPF-12 t

Complete Set Includes:  
1ea. holder  
2ea. R, L  
4ea. 0-9  
1ea. 36-letter case  
(Replacement characters:  
1/4" on 7/8" plastic tabs.  
Reorder #XTSF-1478)



## Illuminated "In Use" Door Signs

Lighted sign focuses attention on exam room status. Enhances Radiation Safety by suggesting the risk of accidental entry into an active exam room. NOT a plug-in sign; must be hardwired @ 120VAC. Each sign measures 11½" x 2½" x 7¾"h. Shipping weight of each sign: 4 lbs.



cat.# (38")	description
SLU-XR	X-RAY IN USE
SLU-CT	CT IN USE
SLU-MR	MRI IN USE



L.E.D. "X-RAY IN USE" Sign  
Power-saving LED light technology meets newer compliance demands. Hardwired sign is 11½" wide x 7¼" high. Shipping weight of each sign: 4 lbs.

cat.# (38")	description
SLU-XL	LED: X-RAY IN USE



## Safe-Spot Safelight

Adjustable swivel & pivot base. Safe for high speed film. Filter is GBX-2 compatible. Pull chain switch. 15-watt incandescent lamp. Shipping weight: 3 lbs.



safe-spot  
#SSP-15

Replacement Filter (Dual Round)  
#SFR-45 \$88.00/ea.  
(Interior bulb can be replaced with 15-watt incandescent bulb.)



## Film Duplicator (copier)

Compact design uses less counter space; single UV lamp. FLAT GLASS contact surface - extremely easy to use. Non-rigid, floppy lid contours to film for excellent contact. Electronic timer with automatic reset. All metal housing. 18"w x 15"d x 12"h. 110 VAC standard. 1 year warranty (excl. glass & bulbs) Shipping weight: 31 lbs.



#195D

EASY! Place the original film and the copy film on the glass. Then, press "expose" and run through any standard processor.

Copy 14" x 17" Film  
with NO Moving Parts!

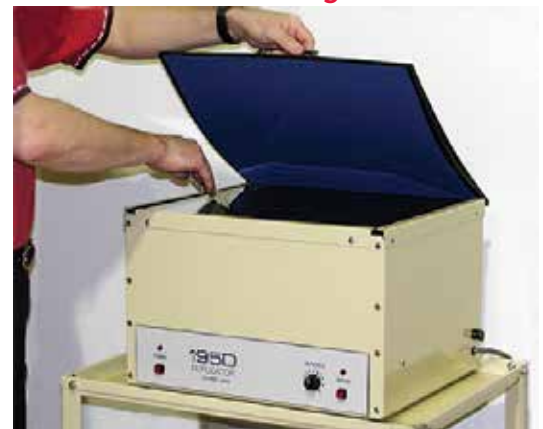

## I.D. Cards - Standard

Standard Cards measure 3" x 5". Each card is imprinted with standard legend. Each pack contains 1,000 cards. Shipped from stock.

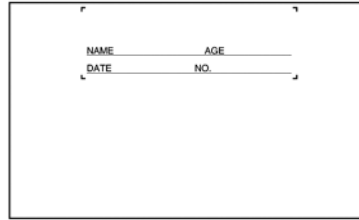

#IDS-02M  
Blank with 2-Line Legend

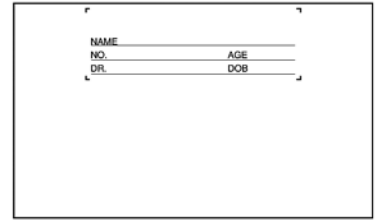

#IDS-03M  
Blank with 3-Line Legend

## I.D. Cards - Custom

Custom Cards measure 3" x 5" with 1" x 3" imprint window (GE and Kodak compatible cards are 3¼" x 7¾" with 1" x 2½" imprint window). Each card is imprinted with: Your Custom Imprint (0, 1, 2 or 3 lines); Custom Legend (0, 1, 2 or 3 lines); (if not specified, standard legend will be used). Each pack contains 1,000 cards.

CUSTOM  
CARD  
BUILDER

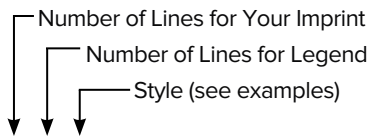

Cat.#	IDC-	Imprint Lines	Legend Lines	Style
	0 0	0	0	M
	1 1	1	1	C
	2 2	2	2	D
	3 3	3	3	Q

style	imprint location	1000 cards	5000 cards*
M	Middle Top		
C	Top Corner		
D	Double Middle		
Q	GE or Kodak (compatible)		

(\*5000 quantity is priced per 1000 cards.)

(When ordering, a faxed diagram is most helpful.)

*Artwork may not be an exact match to that of other suppliers.*

*Custom Cards are non-returnable.*

*If not specified, standard legend will be used.*

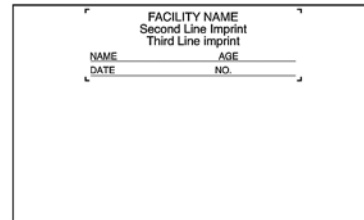

Example:  
#IDC-32M

**Most Popular Card!**

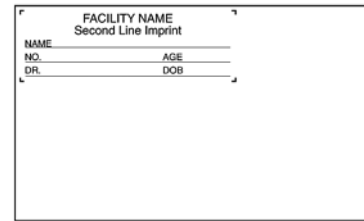

Example:  
#IDC-23C

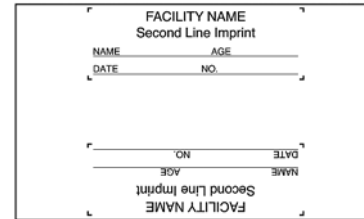

Example:  
#IDC-22D

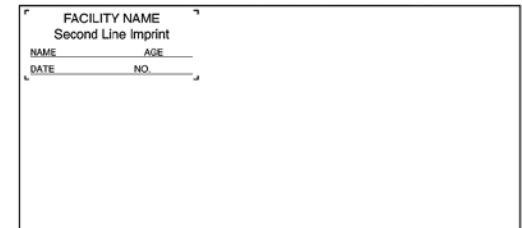

Example:  
#IDC-22Q

## I.D. Printer

Fully automatic exposure for perfect image prints. Adjustable exposure timer for most film types. Film positioning guides for middle or corner ID cards. Durable, all-metal housing. Plug-in model only; 110/120 VAC. 8" w x 8" d x 3" h. Shipping weight: 6 lbs.



#IDP-33

**Accommodates Middle & Corner Cards**

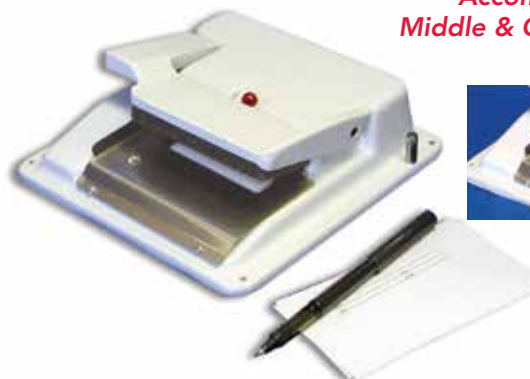

Pin Adapter can be set for use with middle or corner cards.

**NEW!**

## LED Illuminators

Use **70% LESS POWER** than Standard Illuminators! High quality illuminators include upper and lower Film Grips. Internal LED array offers consistent illumination from a matrix of lights per viewing area. Use as stand alone or wall mounted. Average light intensity is 4250 nits. 6 foot power cord with hospital grade plug. UL listed.



single bank LED  
#VBS-10LED

14" w x 3<sup>3</sup>/<sub>8</sub>" d x 21" h  
Shipping weight: 14 lbs.



double bank LED  
#VBD-20LED

28" w x 3<sup>3</sup>/<sub>8</sub>" d x 21" h  
Shipping weight: 33 lbs.

## Standard Illuminators

High quality, cost effective illuminators. Includes upper and lower Film Grips. Internal reflectors offer consistent illumination from two 15-watt fluorescent lamps per viewing area. Use as stand alone or wall mounted. Average light intensity is 2000 nits. 6 foot power cord. UL listed.

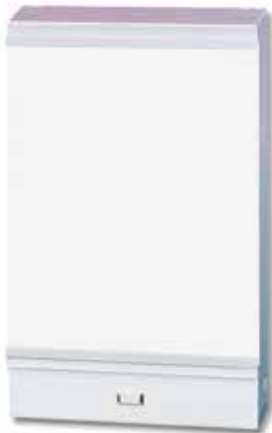

single bank  
#VBS-10

14" w x 3<sup>1</sup>/<sub>2</sub>" d x 21<sup>3</sup>/<sub>4</sub>" h  
Shipping weight: 17 lbs.



double bank  
#VBD-20

28" w x 3<sup>1</sup>/<sub>2</sub>" d x 21<sup>3</sup>/<sub>4</sub>" h  
Shipping weight: 34 lbs.



single bank  
With Film  
Activated Switch  
#VVS-11  
21" w x 19 1/16" d x 20 1/4" h  
Shipping weight: 10 lbs.

## Techno-Vision Illuminators

Over 90% light uniformity from edge to edge. Ultra-Slim design gives a flush mounted look without the need for wall cut-outs. EEFL lighting technology assures years of trouble-free service for up to 50,000 hours! Upper and Lower Film Grips. Film-Activated Switch available. . Average light intensity is 5000 nits. 6 foot power cord. UL listed.



double bank  
With Film  
Activated Switch  
#VVD-21  
35" w x 19 1/16" d x 20 1/4" h  
Shipping weight: 16 lbs.

## Mammography Illuminator

Light source specifically designed to meet ACR Mammography Viewing requirements. Unit offers two (2) side-by-side film viewing areas for 24 x 30 film. Light intensity: 4,200 nits. Upper and Lower Film Grips. White powder coat finish. Includes four (4) 15-watt fluorescent lamps. UL listed with 5-foot power cord. Overall size: 20 1/2" w x 3 1/2" d x 16 3/4" h. Shipping weight: 17 lbs.



#VBM-24



## Spinal Illuminator

Light source designed for Orthopedic and Chiropractic film viewing. Unique viewing area for 14" x 36" film. Includes two 30-watt fluorescent lamps. Upper, Lower, and Mid-Height Film Grips. Stand alone or use the keyhole slots for wall mounting. White powder coat finish. UL listed. Overall size: 15" w x 3 1/2" d x 39" h. Shipping weight: 25 lbs.



#VBO-36



## Standard X-Ray Film Jackets

Choose one or two pockets. Non color-coded (see label selection for sticker styles and colors). Size: 14.5” x 18.25”, including 3/4” scored self expansion. Made of 11pt. manila stock. Black ink copy includes blocks for color-code labels and black loan indicator. Offset double thumbcut for easy access to contents. Double pocket version includes 10” x 15.75” report pocket with 3/4” self expansion. Open side (opens along upper edge).



single pocket

cat#	qty./ctn	wt./ctn	1-9 ctns	10-24 ctns	25+ ctns
JJL-SPS	100	22#			



double pocket

cat#	qty./ctn	wt./ctn	1-9 ctns	10-24 ctns	25+ ctns
JJL-DPS	100	25#			

## Multi-use Jackets

Universal design allows many uses with one folder. Size: 9 9/16” x 12 3/4”, including 3/4” scored self expansion. Made of 11pt. manila stock. Universal copy includes check boxes for different exams. Offset double thumbcut for easy access to contents. Open side (opens along upper edge). (May require long lead-time.)

cat#	qty./ctn	wt./ctn	1-9 ctns	10-24 ctns	25+ ctns
JJM-SPU	200	19#			



## Color-Code Labels

Features permanent adhesive and release coated paper backing. Superior flexibility for long life. Other color systems available.

cat#	description	qty./ctn	1-9 ctns	10-24 ctns	25+ ctns
see list	any single	1000/rl			
JLL-CNS	0-9 set	10 rolls			

cat#	description	qty./ctn	1-9 ctns	10-24 ctns	25+ ctns
see list	any single	1000/rl			
JLS-CCS	set of 10	10 rolls			

large digit reverse block



(shown actual size: 1 7/8" x 1 7/8")

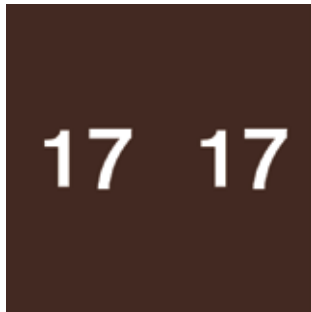

(shown actual size: 1 7/8" x 1 7/8")

large year

cat#	year/color	qty./ctn	1-9 ctns	10-24 ctns	25+ ctns
JLL-Y16	16/yellow	1000/rl			
JLL-Y17	17/brown	1000/rl			
JLL-Y18	18/pink	1000/rl			



Cat.#	Color	Cat.#
JLL-ORD	red	JLS-CRD
JLL-1GY	gray	JLS-CGY
JLL-2BL	blue	JLS-CBL
JLL-3OR	orange	JLS-COR
JLL-4PR	purple	JLS-CPR
JLL-5BK	black	JLS-CBK
JLL-6YL	yellow	JLS-CYL
JLL-7BN	brown	JLS-CBN
JLL-8PK	pink	JLS-CPK
JLL-9GN	green	JLS-CGN
JLL-CNS	(set of 10)	JLS-CCS
--	aqua	JLS-CAQ
--	gold	JLS-CGD
--	wallet	JLS-CNW
--	white	JLS-CWT



solid color bar label



(shown actual size: 1 3/4" x 1 1/2")



(shown actual size: 1 3/4" x 1 1/2")

small year

cat#	year/color	qty./ctn	1-9 ctns	10-24 ctns	25+ ctns
JLS-Y16	16/yellow	1000/rl			
JLS-Y17	17/brown	1000/rl			
JLS-Y18	18/pink	1000/rl			

## Mammography Jackets

Pink border identifies as separate from master jacket. Size: 11" x 14", including 3/4" scored self expansion. Pocket size: 8 1/4" x 11". Illustrated back allows for Dx & patient communication. Offset double thumbcut for easy access to contents. Open side (opens along upper edge).

	cat#	qty./ctn	wt./ctn	1-9 ctns	10-24 ctns	25+ ctns
PINK Border	JJM-PPM	200	30#			
BLUE Border	JJM-BBM	200	30#			



## Category Inserts

Locate specific examinations at a glance using solid-color and printed border stock color systems. Made of 32lb. white stock. Color coding by category permits quick location of films. "Open side" category name is printed on both sides of thumbcut; "open end" category name is printed on top and bottom of insert for easy identification. All inserts are available in open side (long edge) and open end (short edge) styles.

Choose from two sizes:

large: 14.25" x 17.5"

medium: 10.5" x 12.5"



### Large Size

size (inches)	qty./ctn	wt./ctn	1-9 ctns	10-19 ctns	20+ ctns
14.25 x 17.5	250	20#			
open end#	open side#	category	stock	copy	border
JCL-ABE	JCL-ABS	Abdomen	White	Black	Lt. Green
JCL-ANE	JCL-ANS	Angio	White	Black	Purple
JCL-BEE	JCL-BES	BE*	White	Black	Gold
JCL-BNE	JCL-BNS	Bone	White	Black	Yellow
JCL-CHE	JCL-CHS	Chest*	White	Black	Brown
JCL-CTE	JCL-CTS	CT*	White	Black	Dk. Green
JCL-EXE	JCL-EXS	Extremities	White	Black	Yellow
JCL-GIE	JCL-GIS	GI*	White	Black	Gray
JCL-GUE	JCL-GUS	GU*	White	Black	Orange
JCL-HNE	JCL-HNS	Head & Neck	White	Black	Lt. Blue
JCL-IVE	JCL-IVS	IVP	White	Black	Salmon
JCL-MME	JCL-MMS	Mammography*	White	Black	Dk. Blue
JCL-MRE	JCL-MRS	MRI*	White	Black	Rust
JCL-NME	JCL-NMS	Nuclear Med	White	Black	Red
JCL-SEE	JCL-SES	Spine*	White	Black	Black
JCL-USE	JCL-USS	Ultrasound	White	Black	Purple

\*Includes anatomical diagram on back.

size (inches)	qty./ctn	wt./ctn	1-9 ctns	10-19 ctns	20+ ctns
14.25 x 17.5	250	22#			
open end#	open side#	category	stock	copy	border
JCL-NCE	JCL-NCS	(no category)	White	Black	Dk. Blue

### Medium Size

size (inches)	qty./ctn	wt./ctn	1-9 ctns	10-19 ctns	20+ ctns
10.5 x 12.5	250	25#			
open end#	open side#	category	stock	copy	border
JCM-BDE	JCM-BDS	Bone Density	White	Black	Yellow
JCM-MME	JCM-MMS	Mammography	White	Black	Dk. Blue
JCM-NME	JCM-NMS	Nuclear Med	White	Black	Red
JCM-USE	JCM-USS	Ultrasound	White	Black	Purple

## Negative Preservers

Available in three sizes to accommodate all films. All include stock copy lines for: file number, name, date, doctor and remarks. Made of 32lb. gold kraft stock. Thumbcut for easy access to films. Open end (opens along short side edge). Red and green available in large size, upon request.

cat#	size	qty./ctn	wt./ctn	1-7 ctns	8-14 ctns	15+ ctns
JNS-OEK	8.5 x 10.5	500	25#			
JNM-OEK	10.5 x 12.5	500	25#			
JNL-OEK	14.5 x 17.5	250	25#			



## CD/DVD Sleeves

Standard 5" x 5" CD/DVD protectio sleeves. Made of 60lb. white offset paper stock. Window made of clear polyester.

cat#	qty./ctn	wt./ctn	1-7 ctns	8-14 ctns	15+ ctns
JCD-CSW	1000	14#			



## CD/DVD Mailers

Features self-adhesive closure and tear-tape tab opening. Made of 20pt. coated white board. Economy; no liner.

cat#	qty./ctn	wt./ctn	1-7 ctns	8-14 ctns	15+ ctns
JCD-CDX	200	15#			



## Cardboard Insert Mailers

Available in two sizes. Made of 32lb. brown kraft stock. Open end, string & button closure. Chipboard insert for rigidity. Printed with bold black stock copy.

cat#	size (inches)	qty./ctn	wt./ctn	1-7 ctns	8-14 ctns	15+ ctns
JMM-SBC	11 x 13	50	8#			
JML-SBC	15 x 18	50	12#			



## Green Diamond Border Mailers

Available in two sizes. Made of 11pt. manila stock. Open end, string & button closure. Green diamond border with red. "X-Ray Film, please do not bend."

cat#	size (inches)	qty./ctn	wt./ctn	1-7 ctns	8-14 ctns	15+ ctns
JMM-SBD	11 x 13	50	7#			
JML-SBD	15 x 18	50	10#			





## Records & Mammo Organizers

Ideal for Medical Records, Mammo Film, CT, Ultrasound and Nuclear Medicine. Increases file room and transportation efficiency. 2-pocket design is available in six (6) colors with frosty clear pockets. Overall size: 13.5" x 10.75".



cat#	color	qty./ctn	1-4 ctns	5-9 ctns	10-19 ctns	20+ ctns
400	True Blue	20				
410	Red	20				
420	Yellow	20				
430	Green	20				
440	Purple	20				
495	Pink	20				

## Standard Organizers



Allows handling of files without damage to film or jackets. Keeps records and film in one convenient location. Also aids in increased file room and transportation efficiency. Heavy gauge vinyl welded together with heat-seal construction. Sealed chipboard insert for rigidity. Ideal for transport / retrieval protection. 2-pocket design for files and jackets. Holds up to 14" x 17" film. Available in five (5) colors. Overall size: 21" x 14.5".



cat#	color	qty./ctn	1-4 ctns	5-9 ctns	10-19 ctns	20+ ctns
800	True Blue	20				
810	Red	20				
820	Yellow	20				
830	Green	20				
840	Purple	20				

## E-Z X-Ray Storage Boxes

Allows for the efficient storage of x-ray film files. (Sold in case lots.) Strong and durable with reinforced handles. One piece, easy fold assembly. Can be stacked without crushing. Ideal for archiving files, temporary storage, or moving files. Accommodates jackets up to 14" x 17". Upright: lid opens up. Side down: lid opens forward. (printed legend provided both ways.) Sized for OSHA lift load capacity. Each box O.D.: 6.25" x 16" x 19.5". Ships as 30 lbs. per case.

6 cases or less via FedEx/UPS.

7+ cases via motor freight.



Cat.#ETX-70  
(15 boxes per case)

- # cases
- 1-3
- 4-7
- 8-15
- 16-49
- 50+

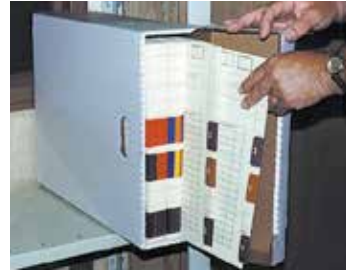

Horizontal Filing



Vertical Filing



## Standard Wall Bins

Non-shielded steel storage solutions. Will hold receptor plates, film jackets, and caddies. Opening is 22"w x 5"d x 14"h.



Standard Version  
with polycarbonate  
see-thru front.

#80AC



HIPAA Version  
with solid steel  
no-see front.

#80HP

## Techno-Tuff™ X-Ray Filing Cabinets

The industry standard cabinets for ARCHIVE or ACTIVE film storage. Fully assembled, tough, and versatile.

Pleasing, aesthetic design. All steel construction offers maximum strength. Solid back and side panels for security. 15<sup>3</sup>/<sub>8</sub>" vertical shelf clearance. 12-gauge corner posts for vertical strength. Dividers are 6" apart. Full height dividers add vertical strength and stability. Full depth dividers prevent snagging and ripping of jackets. Available in seven (7) colors (see color chart).



#618A



#634XST



#633XST



#632XST



#631XST\*

**\*IMPORTANT NOTE about Bases and Stackers:**

All units are shipped as Base Units which include a 3" dustplate, with the exception of the 631XST single-tier unit. This unit is shipped as a Stacker at 17" tall without a dustplate, unless a Base Unit at 20" tall is specified. Stackable units are secured with nuts & bolts.

**632XST with locking DOORS!**

Only available on the 632XST. Flush-mounted paddle handles. Locks offer attractive security. Heavy duty construction.

#DR632XST 36" x 18" x 36"  
Ships @ 170 lbs.



cat#	tier	w x d x h (in.)	ships @	1-4	5-9	10-19	20+
631XST*	1	36x18x20	77#				
632XST	2	36x18x36	115#				
633XST	3	36x18x52	165#				
634XST	4	36x18x68	212#				
618A	5	36x18x84	238#				

36" Wide Quantity Discounts

**SPECIAL NOTE ABOUT MOTOR FREIGHT:**

Please provide information about your receiving area to determine standard or special delivery requirements. Trucking companies will not unload shipments to accounts who do not have a commercial height receiving dock. In most other circumstances, however, special arrangements can be made available at a reasonable extra freight charge.

## Tall Receptor/Filing Cart

Protect your investment! "CRC" CR-Plate Units have special, impact resistant padding on shelves and vertical surfaces to prevent damage to expensive CR-Plates. Accommodates film jackets, cassettes, and IR plates. See opposite page for seven colors of durable enamel finish.

Eight 6" wide compartments @ 16 1/2" vertical clearance. Nominal size: 24" x 18" x 42.5"h. Shipping weight: 130 lbs.

#CRC-38



## Mini Receptor/Filing Cart

Four 6" wide compartments @ 16 1/2" vert. clearance. Nominal size: 24" x 18" x 36"h. Shipping weight: 100 lbs.

#CRC-24



## Mammo Printer Carts

24" Wide Base with Laminate Top for printers, CR readers, digitizers, viewers, monitors, keyboards, and other support or mobile equipment.



Carts are 24" wide x 20" deep x 38.25" tall. Interior configuration: open shelf over large shelf w/dividers. Height of open shelf is 9". Height of shelf w/dividers is 20". Widths of 24" divided spaces are 6"/6"/12". All carts feature three cable holes in the back at each shelf level.

### TOP "25x25"

25" wide x 25" deep top on a 24" wide cart. Compatible suggestions: Vidar Diagnostic ProAdvantage, Kodak DryView 5800/5850, Fuji DryPix 2000, Konica/Minolta DryPro 832, Codonics® Horizon

#DSC-2412C



### TOP "30x30"

30" wide x 30" deep top on a 24" wide cart. Compatible suggestions: Kodak DryView 5800/5850, Array 2905, AllPro ScanX 14, Agfa CR30 / Quantum CR30, Kodak CR120/140/260/500, Sony Filmstation

#DSC-2412D



Equipment is shown for illustration and is not included.

# Electric lift, height-adjustable desks

## Straight Front

The **straight front** is designed to resemble a standard desk and is usually placed against a flat wall.

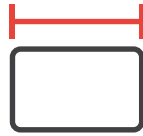

Straight Front

cat.# Length x Depth  
ZLSU-E 48"- 96" x 30"- 36"

## Contour Front

The **contour front** is designed to keep all of the desk surface within easy reach from any position. This desk is usually placed against a flat wall.

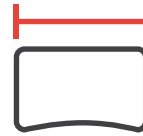

Contour Front

cat.# Length x Depth  
ZLCU-E 60"- 96" x 36"

## Corner View

The **corner view** is designed to keep all of the desk surface within easy reach from any position. This desk is usually placed in a corner.

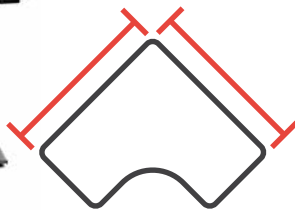

Corner View

cat.# Left Wing x Right Wing  
ZCVU-E 60"- 96" x 60"- 96" (30" wing depth)

## Multi-Purpose Extension

The **multi-purpose extension** is designed to support one-to-two separate viewing or computer systems. This desk can be placed in a corner or against a flat wall.

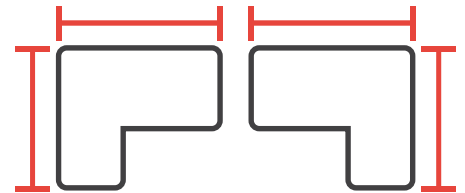

Right Extension

cat.# Left Wing x Right Wing  
ZMPE-ER 60"- 96" (30" deep) x 48"- 72" (24"wide)

Left Extension

cat.# Left Wing x Right Wing  
ZMPE-EL 60"- 96"(30"deep) x 48"- 72"(24"wide)



### ELECTRIC BASE:

Includes 3-position programmable controller. 25" adjustment range: 25.5"- 50.5" (at 1.5"/sec). Load capacity: 300 lbs. Requires less than 3amps of power. Locking casters available. Limited Lifetime Warranty.



### WORK SURFACE:

Laminated solid surface with high endurance PVC edging. Top is supported by a beamless frame that offers generous leg room. Locking casters available. Custom sizes available; please call for quote.

Top Surface Laminates (many others available)			
	Matte Black	Designer White	Gray Mist
	Maple	Persian Cherry	Mahogany
Top Edge Band			
	Black	White	Gray
Leg/Frame	Black	White	Gray

## Elemental Chair & Stool

Comfortably meets all multi-task and office requirements. Back height adjustment. Tilting backrest. Pivot backrest. Tilting seat. Warranty: 7-year limited. Seat: 19”w x 19”d. Back: 19”w x 17.5”h. Stool includes 20” footring.

*Ideal for use with sit-to-stand desks.*

Chair only:

Seat height range: 16”-21”

Overall height: 35”-43”

Ships @ 101# (actual wt. 52#).

Chair No Arms

#ZOEC-MX03

Stool only:

Seat height range: 23”-33”

Overall height: 42”-55”

Ships @ 68# (actual wt. 46#)

Stool No Arms

#ZOES-MX03



## YES™ High-Back

The Perfect blend of support, comfort, and style. Features contoured lumbar area and mesh-back comfort. Easy back height adjustment. Three-stage locking tilt. Synchronous seat/back tilt. Seat slider. Warranty: 12-year limited. Seat height range: 17.5”-22.5”  
Seat: 20.5”w x 18”-20”d.  
Back: 20”w x 24”h with headrest.  
Overall height: 46”-55”  
Ships @ 101# (actual wt. 63#)

High-Back +Arms

#ZOYS-HA03

*Ideal for desks, workstations & everyday tasks.*



## Universal Stool

Self-skinned urethane seat and back. Height adjustable footring. Seat height: 22”-32”. Overall ht: 37”-47”. 7-year limited warranty. Ships @ 37#.

#ZBCH-USB

(Black ONLY, non-upholstered)



## UPHOLSTERY FABRICS

Polyester (celestial)						
	1200-Oberon	1201-Rhea	1203-Callisto	1204-Titan	1207-Hyperion	1208-Europa
Polyester (soft sit)						
	2570-Graphene	2572-Ash	2575-Tsunami	2576-Magma	2577-Molten	2578-Kipuka
Polyester (freedom)						
	3400-Orbit	3401-Stealth	3402-Flight	3403-Cocoa	3404-Evening	3408-Oasis
Vinyl (stage)						
	V50-Cats	V53-Grease	V55-Aida	V52-Chicago	V59-Fame	V58-Shrek

## Workstations

Workstations feature:

- Omni-directional movement
- Dynamic height adjustment

- Components can be easily relocated along support post.
- Includes: 1-31½" wall mount vertical track  
1-extension arm keyboard tray  
1-75mm/100mm VESA swivel mount  
(6.5-lb min / 17.5-lb max monitor capacity)
- Models with CPU Holder include an additional 31½" track (for 63" total) and CPU holder, adaptable for standard or thin CPU casements.

Mobile Workstation includes:  
1-intergrated workstation  
1-steel post (total ht.: 67")  
1-stablizer H-base  
1-cable channel  
4-locking casters

Single View  
Articulating Arm



Mobile Workstation  
#ZTMW-ES21

Wall Mount (no base)  
#ZEVW-AS21

Single View  
Articulating Arm  
w/ CPU



Mobile Workstation  
#ZTMW-ET31

Wall Mount (no base)  
#ZEVW-AT31

## Desktop Articulating Monitor Supports

Economy Articulating Arm

Cat.# ZEMS-SV21

Articulating gas spring  
directional adjustment.  
21" extension range.  
13" height range.  
Weight capacity:  
6.5-lb min./17.5-lb max.  
Pivot/tilt/rotate monitor.  
Clamp mount.



Dual Economy Articulating Arms

Cat.# ZEMS-SV22

Similar to the  
ZEMS-SV21  
to the left.  
Supports two  
monitors on  
independent  
gas spring articulating  
arms. COMBINED weight  
capacity: 35-lbs.



Single Monitor/Keyboard Combo

#ZEMS-MC21

Double-joint extension arm.  
5"-24" extension range.  
17" height range. Monitor  
weight capacity: 20-lb max.  
Pivot/tilt/rotate monitor.  
Includes gel palm rest.  
Clamp mount on 28" pole.



## Fusion-Lift

NO Assembly! NO Tools! Right out of the box you're ready to convert your existing desk into a Sit-to-Stand desk!

The Upper Desk is 35<sup>3</sup>/<sub>8</sub>" x 15<sup>3</sup>/<sub>4</sub>" and will raise your workspace to a height of 20" with infinite height adjustments throughout its vertical range. The Keyboard surface is 26<sup>3</sup>/<sub>8</sub>" x 13" and provides an ergonomic +/-10° tilt. Smooth, gas-assist movement offers a weight capacity of 35-lbs. Easily mobile at only 40-lbs.

#ZKDR-FL



**Make EVERY DESK  
a Sit-to-Stand Desk!**

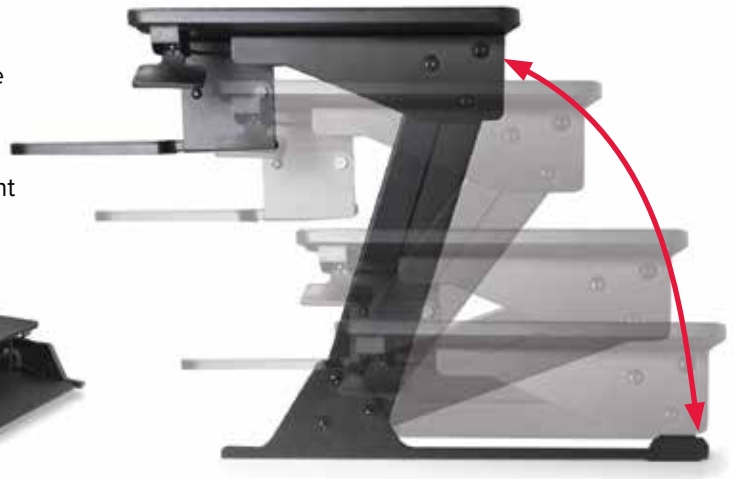

## Trackless Keyboard Support

Spring assisted height adjustment. 5<sup>3</sup>/<sub>4</sub>" height adjustment on a trackless direct mount plate: -1<sup>1</sup>/<sub>4</sub>" to -7" under the surface. +10° to -15° tilt and 360-degree swivel. 19<sup>1</sup>/<sub>2</sub>" wide platform accommodates keyboard. Mouse platform can be placed on either side of the keyboard. Integrated gel palm rest.

#ZKKV-TLS1



Keyboard Supports are not necessary on desks with dual surfaces.

## Cable Management Channels

Pair of 24" "J" channels accommodate multiple cables and wires. Cables are quickly and conveniently stuffed into the channels for out-of-sight capture. Easily installs to the underside of desk with self-adhesive strips or screws (included).

#ZACM-CC



## Universal CPU Caddy

Stores CPU underneath work surface. Features easy-access slide and swivel action. Adjustable width: 2<sup>1</sup>/<sub>2</sub>" to 8<sup>1</sup>/<sub>4</sub>". Adjustable height: 13" to 21". 100 lb weight capacity.

#ZEDA-CPUU



## Mobile CPU Caddy

Stores CPU above the floor for easy access. Fits any CPU within a 3<sup>1</sup>/<sub>2</sub>"-8<sup>3</sup>/<sub>4</sub>" width.

#ZEDA-CPUC

## Locking Casters

#ZAC3-KE (includes 4 casters)  
set of 4

Set of four 3" locking casters. Changes desks into mobile platforms. Easy installation; can be retrofitted. Not recommended for three-legged desks.

Add 3" to your desk height!





# INDEX

index by product number

122E.....90	BEL-90.....42	CRC-24.....115	GSG.....12	MBC-31??.....48	PFC.....14	TA-10??.....86	VFG.....7
195D.....104	BGB.....15	CRC-38.....115	GSL.....12	MBD-68.....48	PLF.....14	TA-122.....91	VFL.....7
1DR.....95	BGB-2.....15	CRH-DFC.....85	GSR.....12	MBE-29.....50	PMA-C4.....38	TA-13.....90	VFR.....7
1E.....90	BHF-10.....41	CRH-MBC.....84	GSS-49.....87	MBE-33.....50	PMA-CB.....38	TA-14.....90	VGG.....6
2DR.....95	BHS-10.....41	CRH-VIC.....84	GWP-??.....88	MBG-3PV.....49	PMR-???.74	TA-16.....91	VGL.....6
2E.....90	BHS-20.....41	CT-EZ1.....85	GXE-55.....87	MBG-6PV.....49	PPAD-???.74	TA-17.....91	VGR.....6
2E-Y.....98	BHW-01.....40	CXR-13E.....44	GXS-57.....87	MBG-6SS.....49	PPAH-???.74	TA-2.....91	VMG.....7
2E-Z.....98	BHW-02.....40	CXR-13S.....44	GXX-58.....87	MBI-70.....48	PPAM-???.74	TA-4.....91	VML.....7
2TA-Y.....98	BHW-03.....40	DBG.....11	HCG.....15	MBI-75.....48	PPGE-???.77	TA-40??.....86	VMR.....7
2TA-Z.....98	BIV-70.....41	DBL.....11	HCL.....15	MBM-MD.....50	PPMS-???.76	TA-5.....91	VS-10?.....44
35LCH.....32	BIV-76.....41	DBR.....11	HCR.....15	MBN-13E.....50	PPSI-???.78	TA-7.....91	VVD-21.....106
3DR.....95	BIV-77.....41	DDD.....11	HGL.....14	MBN-14S.....50	PPTO-???.79	TA-80??.....86	VVS-11.....106
3E-Y.....98	BIV-80.....41	DGG.....11	HGP.....14	MBN-15E.....50	PRL.....14	TA-A3.....98	WBC-XXXX.....36
3E-Z.....98	BIV-81.....41	DGL.....11	HGR.....14	MBN-16S.....50	PS-???.44	TAB-L.....99	WMP-XX.....36-37
3TA-Y.....98	BK-MPGR.....89	DGR.....11	HOG.....15	MBS-68.....48	PSL.....14	TAB-R.....99	WTS-1.....96
3TA-Z.....98	BMS-80.....41	DR632XST.....114	HOL.....15	MBS-65.....48	PSP.....14	TAG.....9	WTS-6A.....96
400series.....112	BMS-95.....41	DRG.....11	HOR.....15	MBW-??.....49	PSR.....14	TAL.....9	WTS-6B.....96
40LDH.....32	BPS-20.....43	DRL.....11	HK-series.....98	MCH-33C.....33	PT-FRB.....92	TAR.....9	WTS-DR.....95
4E.....90	BPS-22.....43	DRR.....11	IDC-series.....105	MCH-37C.....35	PT-SKW.....92	TBB-3272.....51,80	WTW-01.....98
4E-Y.....98	BPS-30.....42	DSC-?????.115	IDP-33.....105	MCH-40C.....34	PT-??.....93	TBC-2214.....66	WTW-23.....98
4E-Z.....98	BPS-32.....42	DSG.....11	IDS-series.....105	MCP-AP.....50	RDF-XX.....83	TBH-2332.....51,80	WTW-45.....98
4TA-Y.....98	BRF-45.....40	DSL.....11	JCD-CDX.....111	MCP-LK.....50	RDH-??.....83	TBN-1872.....51,80	WTW-67.....98
4TA-Z.....98	BSG.....10	DSR.....11	JCD-CSW.....111	MFP-XX.....67	RDP-???.83	TBR-???.80	WTW-80.....98
5E.....90	BSH-65.....40	DVG.....11	JCL-???.110	MKA-19.....99	RDS-12.....83	TBR-2P.....80	WTW-A3.....96
5E-Y.....98	BSL.....10	DVL.....11	JCM-???.110	MKB-12.....99	RDT-??.....83	TBR-B90.....80	XRR-19?.....44
5E-Z.....98	BSR.....10	DVR.....11	JUL-DPS.....108	MKC-15.....99	RDW-??.....83	TBS-ST2.....80	XSCP-10.....103
5TA-Y.....98	BSS-60.....40	DYG.....11	JUL-SPS.....108	MKG-13.....99	RDT-HN.....83	TBS-????.....80	XSEC-11.....103
5TA-Z.....98	BW-??.....81	DYL.....11	JJM-BBM.....109	MKR-11.....99	RDT-SH.....83	TCG.....9	XSEC-12.....103
6EA.....90	BWS-??.....81	DYR.....11	JJM-SPU.....108	MKY-14.....99	RHI-AB.....82	TCL.....9	XSIC-21.....103
6EB.....90	CAL-21.....82	EBG.....4	JJM-PPM.....109	MM-XRAY.....90	RHI-CP.....82	TCR.....9	XSIC-22.....103
6E-Y.....98	CBG.....10	EBL.....4	JLL-???.109	MM-XRAY10.....90	RLC-XX.....83	TDP-????.....30	XSLC-36.....103
6E-Z.....98	CBL.....10	EBR.....4	JLS-???.109	MM-XRAY25.....90	RO-107?.....96	TI-SET.....66	XSLG-21.....103
6TA-Y.....98	CBR.....10	EGG.....6	JML-SBC.....111	MM3003.....101	ROW-series.....96	TM-51323.....47	XSLG-22.....103
6TA-Z.....98	CCC-DR.....39	EGL.....6	JML-SBD.....111	MM3005.....101	S24DR.....94	TMG.....9	XSPF-11.....103
618A.....114	CCD-DR.....39	EGR.....6	JMM-SBC.....111	MM3007.....101	S25DR.....94	TML.....9	XSPF-12.....103
631XST.....114	CCH-24.....39	EMP.....24	JMM-SBD.....111	MPA-19.....99	S30DR.....94	TMR.....9	XSVL-21.....103
632XST.....114	CCH-26.....39	EMS.....24	JNL-OEK.....110	MPR-12.....99	SBC-??.....70	TNG.....9	XSVL-22.....103
633XST.....114	CCL-14.....39	ETX-70.....113	JNM-OEK.....110	MPW-13.....99	SBF-??.....70	TNL.....9	XTIF-3658.....102
634XST.....114	CCL-17.....39	EVG.....4	JNS-OEK.....110	MPY-11.....99	SBG-??.....70	TNR.....9	XTSF-????.....102
7E.....90	CCM-10.....39	EVL.....4	KGG.....13	MRR-22.....99	SBK-??.....71	TPG.....9	XTUA-??.....102
800series.....112	CCM-12.....39	EVR.....4	KGL.....13	MRW-23.....99	SBM-100.....71	TPL.....9	XTUB-??.....102
80AC.....113	CCS-08.....39	FB-10N.....89	KGR.....13	MRY-21.....99	SBP-??.....70	TPR.....9	XTUF-??.....102
80HP.....113	CCS-10.....39	FB-10R.....89	KK-???.13	MSB-NF??.....51	SBS-??.....70	TVG.....9	XVFW-????.....102
80LL.....31	CCZ-14.....39	FB-10W.....89	KMG.....7	MWG.....8	SDM-A1.....100	TVL.....9	YB??.....63
A24DR.....94	CCZ-17.....39	FB-20N.....89	KML.....7	MWL.....8	SDM-BB?.....100-101	TVR.....9	YC??.....63
A25DR.....94	CDK-11?.....44	FB-20W.....89	KMR.....7	MXG.....8	SDM-CT1.....101	TW-200.....88	YCWb.....37
A30DR.....94	CDR-12?.....44	FB-40N.....89	LER-6???.17	MXL.....8	SDM-CT2.....101	TWG.....9	YF??.....63
A-3.....98	CGG.....10	FB-40W.....89	LER-9???.16	NCP-24?.....44	SDM-NS?.....100-101	TWL.....9	YG??.....68-69
ACB-28.....15	CGL.....10	FBG.....4	LER-A???.16	NFD-22B.....44	SDM-W??.....100	TWR.....9	YK??.....63
AGR-105.....21	CGR.....10	FBL.....4	LER-C???.16	NFD-22R.....44	SDW-SS3.....100	TYG.....9	YS??.....63
AGR-110.....21	CMF-01.....45	FBR.....4	LER-D???.17	OGG.....5	SFG.....7	TYL.....9	YV??.....64-66
ARG-06.....20	CMM-06.....45	FLB-series.....31	LER-P???.18	OGL.....5	SFL.....7	TYR.....9	ZCVU.....116
ARH-01.....20	CMT-IV.....66	FLS-78.....31	LER-T???.17	OGR.....5	SFR.....7	UGP-UL1.....47	ZACM-CC.....119
ARH-10.....20	CMT-MPI.....66	FVG.....4	LER-V???.18	OMG.....15	SGG.....11	UGP-UL3.....47	ZBCH-USB.....117
ARM-100.....20	CMT-O2.....66	FVL.....4	LES-53???.18	OML.....15	SGL.....11	UGW-ULD.....47	ZEDA-CP.....119
ARM-G60.....20	COP-1.....96	FVR.....4	LES-AF???.19	OMR.....15	SGR.....11	UGW-101.....47	ZEDA-CS.....119
ARM-Z10.....20	COP-2.....96	GBR-L.....12	LES-C???.19	ORG.....5	SI-144.....45	UGW-102.....47	ZLCU.....116
ARM-ZNH.....20	CP-13.....97	GBR-M.....12	LES-RXPL.....19	ORL.....5	SI-48.....45	UGW-UL1.....47	ZLSU.....116
ARP-02.....21	CP-14.....97	GBR-S.....12	LGG.....11	ORR.....5	SKG.....13	UGW-UL2.....47	ZMPE.....116
ARP-06.....21	CP-34.....97	GBS-3.....12	LGL.....11	PAD-51.....72	SKL.....13	USB-012.....46	ZOEC.....117
ARP-08.....21	CP-35.....97	GDR.....12	LGR.....11	PAD-R2.....72	SKR.....13	USC-025.....46	ZOES.....117
ARW-10.....21	CP-36.....97	GFG5.....12	LGS-09.....82	PAD-S1.....72	SLU-CT.....104	USC-100.....46	ZOYS.....117
ARW-L5.....21	CP-37.....97	GFL5.....12	LGS-B11.....82	PAD-SP???.73	SLU-MR.....104	USC-500.....46	ZTMW-????.....118
ARW-R5.....21	CPH-LD12.....31	GFR5.....12	LKG.....13	PAH-????.....73	SLU-XL.....104	USO-025.....46	
BAG-35.....41	CPH-LL12.....31	GMC-21.....87	LKL.....13	PBMB-3024.....27	SLU-XR.....104	USO-048.....46	
BAG-45.....41	CPP-40.....97	GMC-22.....87	LKR.....13	PBMB-3060.....27	SRG.....5	USO-100.....46	
BAS-30.....43	CPP-42.....97	GME-60.....98	LNA-20.....101	PBMB-4830.....27	SRL.....5	USO-500.....46	
BAS-40.....43	CPP-60.....97	GMI-65.....98	LPG.....10	PBMB-4836.....27	SRR.....5	USP-????.....46	
BBD-63.....40	CPP-61.....97	GMG4.....12	LPL.....10	PBMB-7236.....27	STG.....11	VBD-20.....106	
BBD-64.....40	CPT-R115.....95	GML4.....12	LPR.....10	PBMB-7830.....26	STL.....11	VBG.....6	
BBH-68.....40	CPT-R45.....95	GMR4.....12	LPS-?????.28-29	PBMW-2472.....26	STR.....11	VBL.....6	
BBH-69.....40	CRA-15.....45	GNG.....12	LTG.....11	PBMW-2484.....26	SSP-15.....104	VBM-24.....107	
BBS-61.....40	CRA-16.....45	GNL.....12	LTL.....11	PBMW-3072.....26	TA-001.....91	VBO-36.....107	
BBS-62.....40	CRA-17.....45	GNR.....12	LTR.....11	PBMW-3084.....26	TA-002.....91	VBR.....6	
BEH-93.....42	CRA-18.....45	GPC-23.....87	MBC-30??.....48	PBMW-3672.....26	TA-1.....91	VBS-10.....106	

“-series” or “???” in a catalog number denotes multiple products with a common prefix.